



# AlfaNova 14, 27, 52, 76 and 400

AlfaNova 14, 27, 52, 76 and 400 - Fusion-brazed Plate Heat Exchangers

## Applications

### Within Refrigeration:

- Oil cooler
- Condenser
- Evaporator
- Economizer
- Desuper heater
- Absorption systems

### Other main applications:

- Domestic hot water heater
- Process cooling
- Hydraulic oil cooling
- Laser cooling
- Hygienic/sanitary
- Water/water cooling & heating

### Working principles

The heating surface consists of thin corrugated metal plates stacked on top of each other. Channels are formed between the plates and corner ports are arranged so that the two media flow through alternate channels, always in counter-current flow. The media are kept in the unit by a bonded seal around the edge of the plates. The contact points of the plates are also bonded to withstand the pressure of the media handled.

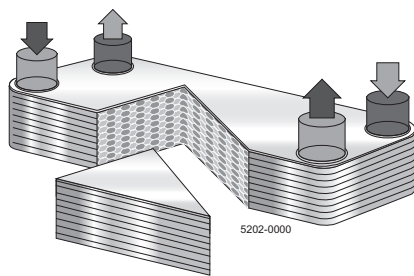

Flow principle of an AlfaNova plate heat exchanger

### Standard materials

Cover plates	.....	Stainless steel AISI 316
Connections	.....	Stainless steel AISI 316
Plates	.....	Stainless steel AISI 316
AlfaFusion filler	.....	Stainless steel AISI 316

## Dimensions

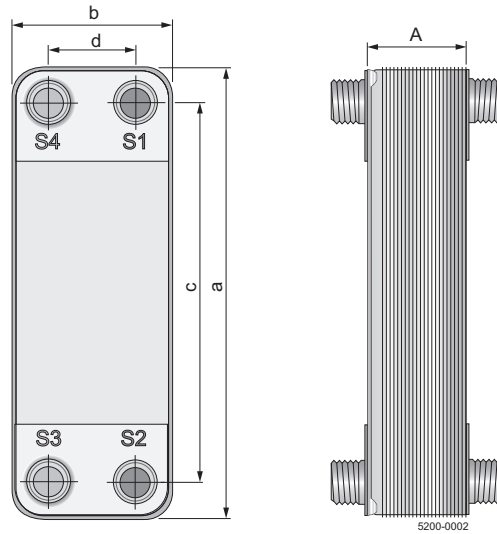

## Fusion bonded plate heat exchanger (FHE) data and dimensions

	AlfaNova 14	AlfaNova 27	AlfaNova 52	AlfaNova 76	AlfaNova 400
Channel type	H	H, L	H, L	H, A, E	H, L
Max./min. design temperature [°C]	175/160	175/160	175/160	175/160	175/160
Max. design pressure S3-S4/S1-S2 [PSI] *)	21/21	27/22	27/22	27/22	17/17
Volume/channel [litres]	0.02	0.05	0.095	0.25 <sup>1</sup> /25	0.74
Max. flowrate [m <sup>3</sup> /h] **)	4.5	7.5	14.5	34	170
Height a [mm]	207	310	526	618	990
Width b [mm]	77	111	111	191	390
Vertical connection distance, c [mm]	172	250	446	519	825
Horizontal connection distance, d [mm]	42	50	50	92	225
Plate pack length, A [mm]	(n x 2.35) + 8	(n x 2.4) + 11	(n x 2.85) + 11	(n x 2.85) + 11 <sup>3</sup> )	(n x 2.65) + 14
Weight empty [kg]	(n x 0.046) + 0.74	(n x 0.13) + 1.5	(n x 0.23) + 2.2	(n x 0.47) + 11 <sup>***</sup>	(n x 1.5) + 44 <sup>***</sup>
Standard connection, external thread [inch]	2"/3"	1¼"/1"	1¼"/1"	2"	4"
Plate material	Stainless steel				
Connection material	Stainless steel				
Bounding material	Stainless steel				
Max. number of plates	50	100	150	150	270
Radiator heating, capacity [kW] <sup>2</sup>	90	400	500	1200	3300
Tap water heating, capacity [kW] <sup>2</sup>	60	180	380	700	2700

\*) according to PED

\*\*) water at 5 m/s (connection velocity)

\*\*\*) Weight with test and LI-S12 flanges

n = number of plates

1) E channel 0.18/0.18 - A channel 0.18/0.25

2) Vanes from country to country depending on temperature only. Given values are for typical district heating installations.

3) Valin for H-plate

## Standard connections

External thread connection

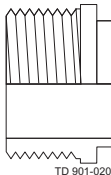

Sweat connection

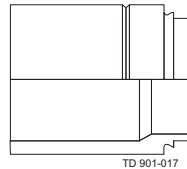

Internal thread connection

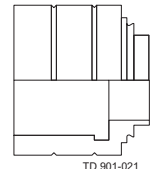

**CE approval pressure/temperature graph**

(Alfa Nova HP 14)

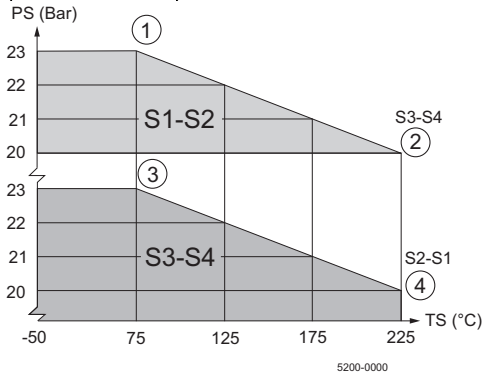

**CE approval pressure/temperature graph**

(Alfa Nova HP 27)

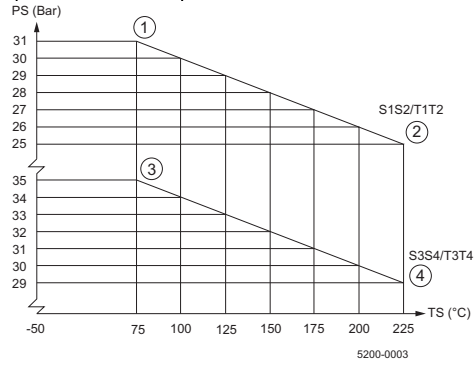

**CE approval pressure/temperature graph**

(Alfa Nova HP 52 - HP 76)

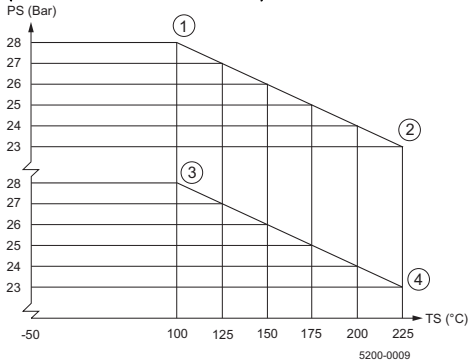

**PED approval pressure/temperature graph**

(AlfaNova 400)

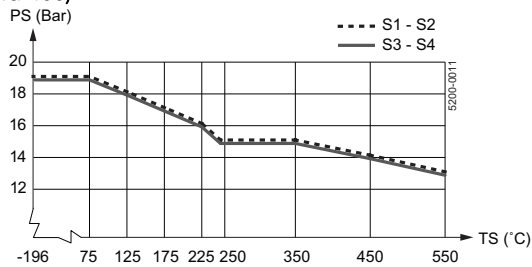

Min. temperature -50°C (-58°F) with connection tubes made of carbon steel.

**ASME approval pressure/temperature graph**

(AlfaNova 400)

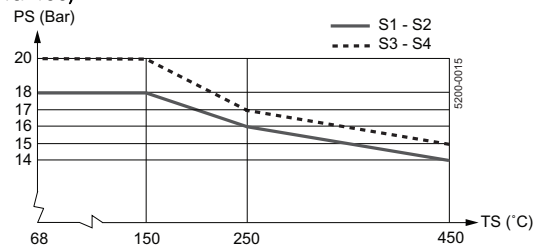

Min. temperature -49°C (-45°F) with connection tubes made of carbon steel.

**PED approval pressure/temperature graph**

(AlfaNova HP 400)

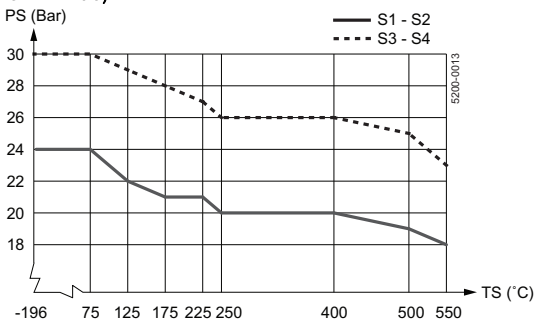

Min. temperature -50°C (-58°F) with connection tubes made of carbon steel.

**PED approval pressure/temperature graph**

(AlfaNova HP 400)

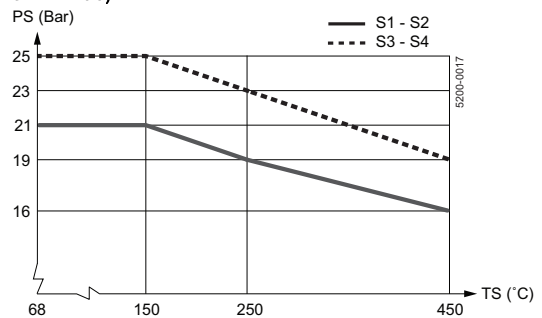

Min. temperature -49°C (-45°F) with connection tubes made of carbon steel.

Alfa Laval reserves the right to change specifications without prior notification. ALFA LAVAL is a trademark registered and owned by Alfa Laval Corporate AB.

ESE00260EN 1201

© Alfa Laval

---

**How to contact Alfa Laval**

Contact details for all countries are continually updated on our website. Please visit [www.alfalaval.com](http://www.alfalaval.com) to access the information direct.