



Marine essentials

Equipment and services for marine applications





You can also explore our products
online at www.alfalaval.com/marine

New times, new challenges

The marine industry is changing with ever-increasing speed. There are new fuels, new laws and new demands concerning energy consumption and the environment. Whether you build ships or sail them, you need solutions and expertise to stay ahead.

You'll find both at Alfa Laval.

No other supplier offers such a wide range of proven equipment, covering most critical operations on board. Nor will you find greater competence in merging

equipment into full applications and innovative solutions to your challenges.

Our decades of work with shipyards, ship owners and ship operators are vital in this respect. Meeting the future is impossible without a true understanding of where things stand today – an understanding we've earned through a century of marine service.

Rest assured, we'll be here to serve you tomorrow as well.



Peter Leifland

Peter Leifland
President, Marine & Diesel Division

Steam and hot water production
p. 62–65, in chapter
Steam and heat generation

Waste heat recovery
p. 80–82, in chapter
Waste heat recovery

Thermal fluid heating systems
p. 66, in chapter
Steam and heat generation

Cooling and heating
p. 24–30, in chapter
Cooling and heating

EGR water treatment
p. 38, in chapter
Emission control

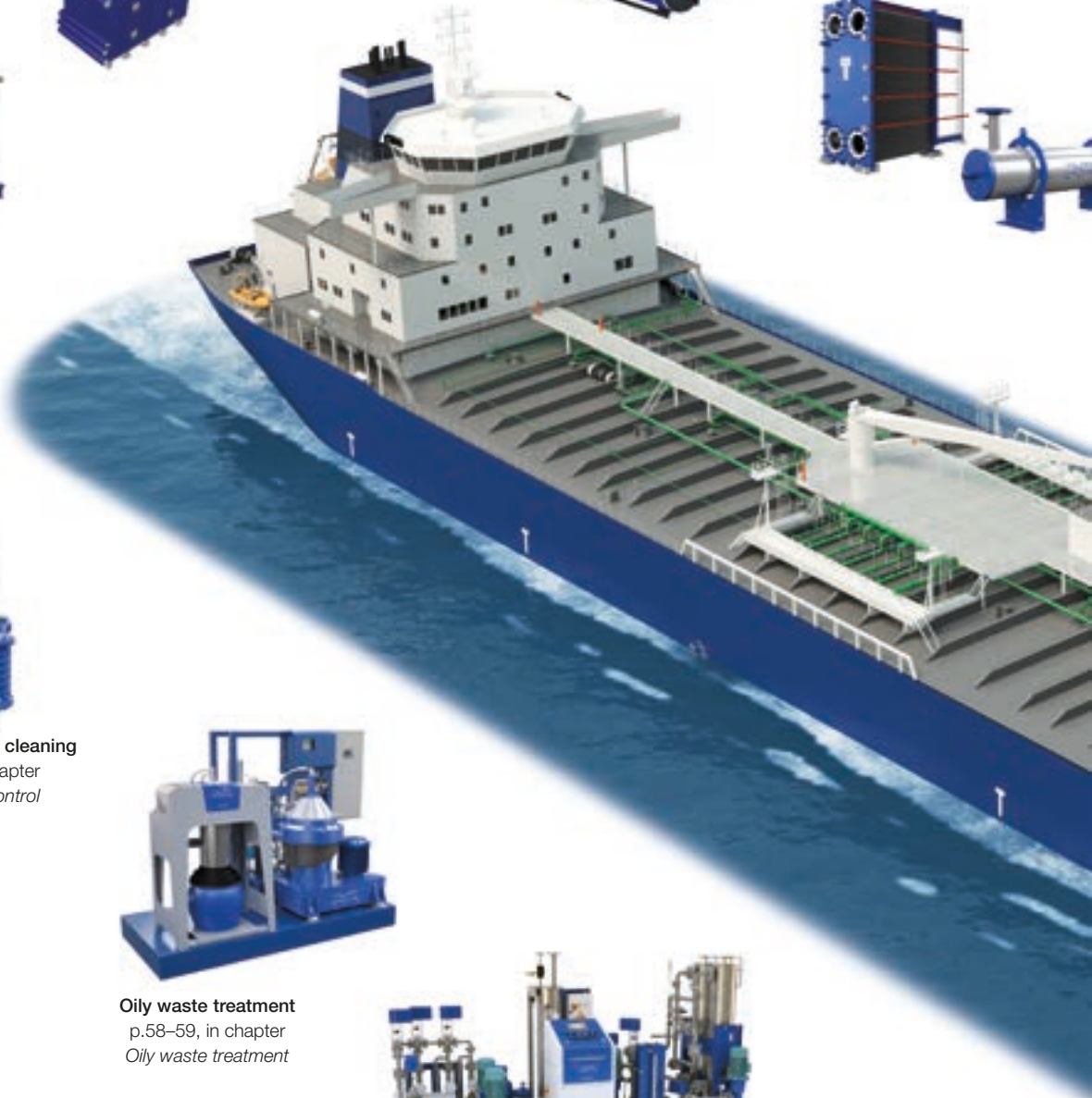
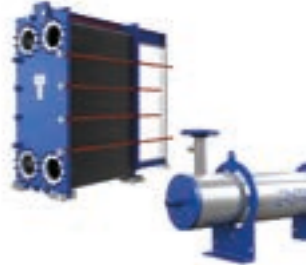

Exhaust gas cleaning
p. 36–37, in chapter
Emission control



Crankcase gas cleaning
p. 39, in chapter
Emission control



Oily waste treatment
p.58–59, in chapter
Oily waste treatment



Fuel conditioning
p. 49–51, in chapter
Fuel and oil treatment



Filtration
p. 52, in chapter
Fuel and oil treatment

Alfa Laval on board

The ease of use, cost efficiency and high reliability that characterize Alfa Laval solutions have made them an essential part of life on most ships worldwide. Our growing portfolio of equipment – already the marine industry's largest – contributes to virtually all key applications on board.



Desalination
p. 32–34, in chapter
Desalination



Ballast water treatment
p. 14–15, in chapter
Ballast water treatment



Inert gas production
p. 74–77, in chapter
Tanker safety



Gas combustion
p. 56, in chapter
Gas combustion



Cargo pumping
p. 18–19, in chapter
Cargo handling



Sold and serviced
by Framo AS only



Tank cleaning
p. 71–72, in chapter
Tank cleaning



Oil cleaning
p. 42–48, in chapter
Fuel and oil treatment



Solutions are here now

As we look for the answers to tomorrow's challenges, we never lose sight of the needs of today. Alfa Laval has a comprehensive offering, adapted to essential aspects of business at sea. Our equipment, systems and services cover everything from critical operations to lighter duties, providing both lifecycle economy and long-term peace of mind.

BALLAST WATER TREATMENT 13

Alfa Laval has the leading offering in ballast water treatment, based on the industry's best-performing treatment system. Alfa Laval PureBallast 3.1 provides capabilities no other system can match.

- › Ballast water treatment 14–15

CARGO HANDLING 17

Framo hydraulically driven submerged cargo pumps provide safe, efficient and flexible handling of any liquid cargo. Their performance gives quicker turnaround, more ton-miles and fewer voyages in ballast.

- › Cargo pumping 18–19
- › Cargo heating 20
- › Ballast water pumping 21
- › Anti-heeling 21
- › Piping 21

COOLING AND HEATING 23

Efficient Alfa Laval heat exchangers let you take full control – and full advantage – of the thermal energy on board. A complete selection ensures the best lifetime match between product and function.

- › Engine and auxiliary cooling 24
- › Steam heating and condensing 24
- › Gas handling 25–26
- › Electric heating 27
- › Oil and water preheating 27
- › Dump condensing and tank cleaning 28
- › Oil and chemical heating 28
- › Oil and water heating and cooling 29
- › Filtration 29
- › Cleaning-in-Place 30

DESALINATION 31

Proven processes merge with state-of-the-art advances in Alfa Laval freshwater generators. Our revolutionary AQUA technology supplies quality fresh water with less energy and environmental impact.

- › Seawater desalination 32–33
- › Water heating and circulation 34

EMISSION CONTROL 35

Tougher emission regulations are a pressing concern for ship owners and operators. Alfa Laval has solutions that safeguard compliance while minimizing the impact to your vessel and its bottom line.

- › Exhaust gas cleaning 36–37
- › EGR water treatment 38
- › Crankcase gas cleaning 39

FUEL AND OIL TREATMENT 41

Alfa Laval has treatment solutions for a wide range of oils and a growing number of fuels. Built with leading expertise, our modular solutions offer thorough protection and high energy efficiency.

- › Oil cleaning 42–48
- › Adaptive feed control 48
- › Fuel conditioning 49–51
- › Filtration 52
- › Pumping 53

GAS COMBUSTION 55

Combusting boil-off lets LNG vessels with dual-fuel or low-speed diesel engines regulate cargo tank pressure. The Alfa Laval Gas Combustion Unit (GCU) is part of our growing portfolio of LNG solutions.

- › Gas combustion 56

OILY WASTE TREATMENT 57

Treating oily waste means dealing with oil, but also with chemicals, particles and large volumes of water. Alfa Laval's compliant solutions mean less waste to dispose of – and less money wasted.

- › Bilge water treatment 58
- › Waste fuel recovery 59

STEAM AND HEAT GENERATION 61

Alfa Laval Aalborg boilers and thermal fluid systems have a long history, yet remain at the cutting edge. Their modular construction and many options allow energy-optimized solutions for any vessel.

- › Composite boilers (oil-fired + exhaust gas) 62
- › Small- and medium-capacity boilers (oil-fired) 63
- › Large-capacity boilers (oil-fired) 64
- › Composite boilers (dual-fuel + exhaust gas) 64
- › Small- and medium-capacity boilers (dual-fuel) 65
- › Large-capacity boilers (dual-fuel) 65
- › Thermal fluid heating systems 66
- › Thermal fluid system control 67

TANK CLEANING 69

Alfa Laval Gunclean Toftejorg equipment cleans your tanks with a fraction of the time and cleaning fluid. By assessing your tank in three dimensions, we ensure a fully optimized installation design.

- › Tank cleaning technology 70
- › Tank cleaning machines 71
- › Cleaning optimization software 72

TANKER SAFETY 73

Alfa Laval Smit systems for inert gas production represent decades of experience in tanker safety. Many production methods and a modular construction allow a perfect match for your vessel and cargo.

- › Inert gas production 74–77

WASTE HEAT RECOVERY 79

By recovering waste heat, Alfa Laval Aalborg solutions are a smart way to save fuel. They reclaim surplus energy that exists on board, using it to provide steam, heat, electricity or even propulsion.

- › Main heat recovery 80–81
- › Auxiliary heat recovery 82

SERVICE 83

The experts of our Alfa Laval Service team are skilled in extending performance. Available worldwide and 24/7, they help you optimize your equipment and maximize uptime throughout its life cycle.

- › Extending performance across the world 84–85
- › Extending performance in 360° 86–87
- › Start-up services 88
- › Maintenance services 89–90
- › Support services 91–92
- › Improvement services 93–94
- › Monitoring services 95

Approaching tomorrow today

The future is no longer as distant as it once seemed. Nor is it as simple. That's why Alfa Laval channels efforts into three focus areas: Energy Efficiency, Pure Thinking and Extending Performance. Each is important in its own right, but also tied to the others.

Energy Efficiency is approaching energy on board from every possible angle. Wherever energy can be saved, it improves your bottom line. We support EEDI compliance, working to reduce fuel use and related costs in applications throughout your vessel. Besides optimizing current fuel technologies, we actively pursue tomorrow's alternatives – and minimize the energy impact of new equipment required by legislation.

Legislation is a driver of **Pure Thinking**, our push to help marine businesses meet environmental challenges. Concerned about maritime industry's impact, we're committed to reducing it without complicating life on board. We strive for workable, sustainable solutions that meet legislative demands while going unnoticed. And as we contribute new solutions, we use our growing knowledge to improve our past contributions.

Integral to both areas – and indeed to everything we do – is our dedication to **Extending Performance**. As slow steaming, new fuels and new regulations change the way you operate, Alfa Laval is a constant that can keep you going strong. Alfa Laval Service is readily available wherever you sail, with solutions to protect your uptime and to keep your equipment optimized for success in a changing world.

Energy Efficiency



Pure Thinking



Extending Performance

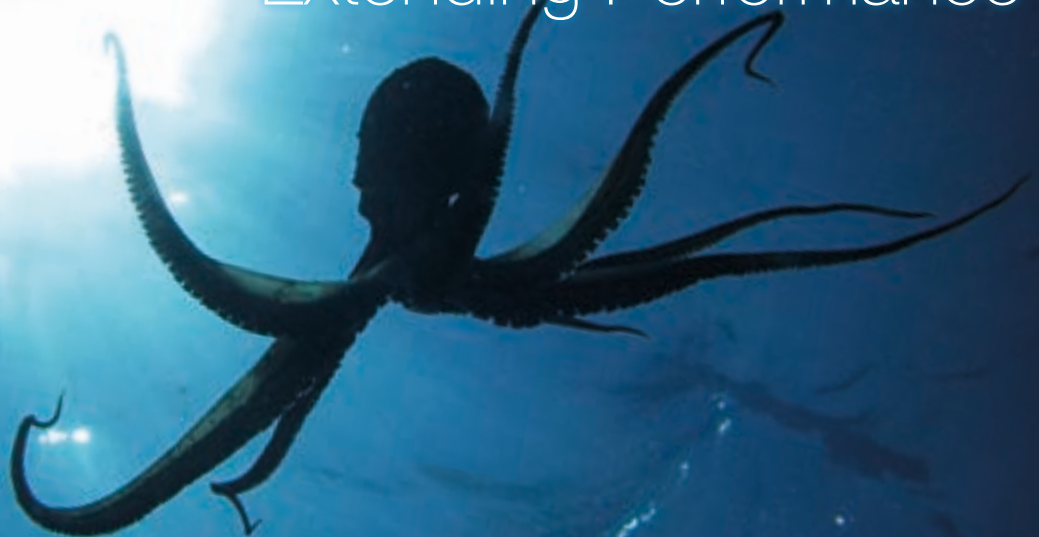

Making waves

Efficient cargo pumping

The Framo cargo pump is of a robust construction made to efficiently empty any cargo tank containing the most heavy, viscous or aggressive cargoes.

The hydraulic driveline is designed for safe and reliable pumping and final stripping of the most volatile or dangerous cargoes carried in bulk.

[Read more on p. 17](#)



Ballast water treatment

As legislation begins to take effect, the urgency of choosing the right ballast water treatment system is growing. The limitations of your system will place limits on your business – by restricting your vessel's movements, operations or resale potential.

Only Alfa Laval PureBallast 3.1 offers all the possibilities. Energy efficient, it performs in all waters: fresh, brackish and marine. It is also ideal for low-clarity water, operating at full flow where UV transmittance is as low as 42%.

[Read more on p. 13](#)



Compliance in SOx ECAs

There are two common ways to comply with sulphur limits in SOx ECAs (Emission Control Areas): switch to MGO/MDO, or install a SOx scrubber and continue with economical HFO.

Alfa Laval is committed to both choices. If you choose distillate, we ensure safe and efficient fuel changeover with the Alfa Laval Automated Fuel Changeover System (ACS) or the Alfa Laval FCM One booster. If you choose a scrubber, Alfa Laval PureSOx is the proven solution, trusted for its reliability and flexibility.

[Read more on p. 49, 36, 51](#)



Solutions for LNG

No longer limited to tankers, the use of LNG is expanding. So is Alfa Laval's LNG portfolio, which includes inert gas generators, gas combustion units, burners, boilers and heat exchangers.

Recently we acquired manufacturing capabilities for printed circuit heat exchangers, and we signed a patent license agreement for high-pressure fuel gas supply systems. Both will allow further development of our fuel conditioning systems for LNG as a primary, secondary or even tertiary fuel.

[Read more on p. 26, 50](#)





Waste fuel recovery

Waste oil is a problem from multiple perspectives. It contains a significant amount of liquid, which means large volumes to be landed or pumped onto barges. Moreover, much of that liquid is fuel.

Alfa Laval PureDry is the only solution that can remove every drop of liquid from waste oil, leaving only super-dry solids. If separate tanks are used for fuel and lube waste, this revolutionary separator can even recover reusable fuel – as much as 1-2% of your vessel's fuel consumption.

[Read more on p. 59](#)



Adaptive fuel treatment

Alfa Laval led the way in adaptive oil treatment with Alcap, which lets the Alfa Laval S separator adjust automatically to oil composition. Today, the Alfa Laval adaptive fuel line offers even more efficient engine protection.

Synchronization with the engine load is a key aspect. Alfa Laval FlowMate reduces energy consumption by steplessly adjusting the separator feed. This also gives the oil more time in the separator bowl, which enhances the S separator's already leading cat fine removal.

[Read more on p. 42, 48](#)



Contribution to EEDI

For new vessels, the Energy Efficiency Design Index (EEDI) is an important parameter. While the choice of engine and hull design are key to achieving EEDI targets, waste heat recovery with Alfa Laval Aalborg systems can contribute to a successful rating.

Waste heat recovery offers much more than steam for direct use. It can be used to generate electricity, which can be diverted to a motor in the shaft line for use in propulsion. This has a positive influence on your EEDI rating.

[Read more on p. 79](#)



Handling of multiple fuels

Stricter emissions limits have led to a rapid diversification of maritime fuels. Traditional HFO, MGO and MDO are now joined by LNG, LPG, DME, methanol, ethanol and DME.

These additional fuels pose new challenges, from extreme pressures to lower temperatures demanded by low fuel flashpoints. Drawing on full application knowledge and fuel conditioning experience no other supplier can match, Alfa Laval is meeting these challenges with solutions like the Alfa Laval Low-Flashpoint FCM One.

[Read more on p. 50](#)





Ballast water treatment is no longer tomorrow's issue. As legislation enters into force, more customers than ever are negotiating and installing their ballast water treatment systems. The questions today are not only about compliance, but also about operating and business flexibility.



Ballast water treatment

Compliance with all the possibilities

Alfa Laval has worked with ballast water treatment for more than a decade. As the very first commercially available ballast water treatment system, Alfa Laval PureBallast defined the forefront at the time of its launch – and still does today.

PureBallast 3.1 represents a complete range of solutions for both newbuild and retrofit needs, including the needs of smaller vessels. Providing a capability range unequalled by any other system, it allows vessels to comply with IMO and US Coast Guard regulations without restricting their business potential.

Performance without compromise

PureBallast 3.1 offers unmatched biological disinfection performance in any type of water: fresh, brackish or marine. This includes water in liquid form at frigid temperatures, as well as low-clarity water. Even where UV transmittance is as low as 42%, the system performs at full flow.

For vessels with PureBallast 3.1 installed, this means energy-efficient compliance with maximum freedom of movement. Running at just 50% of its potential operating power in most situations, PureBallast 3.1 can be ramped up to full power for the most difficult operating scenarios.

Ballast water treatment

PureBallast 3.1

Alfa Laval PureBallast 3.1 is an automated inline system for the biological disinfection of ballast water. Operating without chemicals in all water types, it combines initial filtration with an enhanced form of UV treatment to remove organisms in accordance with IMO and USCG limits. Disinfection occurs in an enhanced UV reactor, whose specially designed synthetic quartz lamp sleeves support transmission of a broader wavelength spectrum and provide 10% more UV light. Combined with the reactor's internal design and the system's power ramp-up capabilities, this ensures optimal UV dosage and unmatched biological disinfection performance. Full-flow treatment is possible even in low-clarity waters, including waters where the UV transmittance is as low as 42%.

- Superior performance in all water types: fresh, brackish and marine
- Optional configuration as a two-water solution for brackish and marine water
- Full-flow treatment of water with UV transmittance as low as 42%
- Treatment of water in liquid form at frigid temperatures

- Fully automated, chemical-free operation
- Typical operation at 50% power utilization, with ramp-up to full power for low-clarity waters
- Flexible installation based on compact modular components
- Flow rates of 32-3000 m³/h with a standard system
- Complete newbuild and retrofit solutions, including ownership support and Performance Agreements

Equipment:

- Filter
 - Basket filter design (three-water system)
 - Candle filter design (two-water system)
- Reactor
- Lamp drive cabinet
- Cleaning-in-Place (CIP) unit
- Control cabinet
- Auxiliary equipment



Alfa Laval PureBallast 3.1 (1000 m³/h)

PureBallast 3.1 (EX systems)

Alfa Laval PureBallast 3.1 is available in a range of EX configurations, for example for Zone 1, IIC and T4 compatibility. EX designs are simplified by the flexible placement of the lamp drive cabinets, which can be located outside the hazardous zone and up to 150 m away from the reactors they serve. Certain standard features are also relevant to EX systems, such as the connection of the reactor temperature and level sensors via safety relays that bypass the PLC.

Safe and energy-efficient treatment

Treatment with PureBallast 3.1 is non-toxic, virtually instantaneous and performed in a closed chamber with no risk to the vessel or crew. It is also energy efficient, thanks to the high biological disinfection performance. Running at 50% of its potential operating power in most situations, the system can be ramped up to full power when needed, for example to handle low-clarity waters with extremely low UV transmittance.

PureBallast 3.1 (Compact)

Alfa Laval PureBallast 3.1 can be configured in a range of compact solutions optimized for smaller vessels, including skid-mounted solutions. These fully automated inline systems use the same enhanced UV technology and offer the same biological disinfection performance as their larger counterparts. With a skid-mounted construction, a PureBallast 3.1 system is both highly compact and easy to install due to minimized pipework.

- Configurations specifically designed for flows of 32-170 m³/h
- Minimal footprint
- Skid-mounted construction
- Integration of the lamp drive and control cabinets into a single electrical cabinet
- Connection via simple plug-and-play contacts



Skid-mounted Alfa Laval PureBallast 3.1 (170 m³/h)



Framo hydraulically driven submerged cargo pumps provide safe, efficient and flexible cargo handling of any type of liquid cargo. Improved cargo handling performance gives quicker turnaround time, more ton-miles and fewer voyages in ballast.



Sold and serviced by
Framo AS only

 An aerial photograph of a large cargo ship sailing on the ocean. The ship is viewed from the stern, moving away from the viewer. The hull is yellow with a red stripe at the bottom. The deck is dark red. The ship is leaving a white wake in the blue water. The text 'Cargo handling' is overlaid in large white letters at the bottom of the image.

Cargo handling

Made to perform

The Framo cargo pump is of a robust construction made to efficiently empty any cargo tank containing the most heavy, viscous or aggressive cargoes.

The hydraulic driveline is designed for safe and reliable pumping and final stripping of the most volatile or dangerous cargoes carried in bulk.

There is no risk of any build up of heat, due to a fail-safe design where the pump motor and bearings are constantly lubricated and cooled.

Load any type of cargo

The Framo cargo pump can handle any type of cargo. One voyage it may be a petroleum product, the next voyage an acid or something heated, cooled, volatile or viscous.

The Framo cargo pump also allows efficient switching between different cargoes. A cargo pumping system must be able to discharge, drain and clean the cargo tanks in an efficient manner to make the vessel ready to receive a new cargo.

Cargo pumping

Framo submerged cargo pump

The Framo cargo pump is a vertical single-stage centrifugal pump powered by a hydraulic motor for safe and efficient operation. All Framo cargo pumps are made of stainless steel and designed with a smooth and easy-to-clean surface with a limited number of flanges, which gives them a superior ability to pump any liquid.

Design features:

- Vertical single-stage, single-suction impeller, axially balanced
- Robust hydraulic drive with short and stiff drive shaft
- Fail-safe design – pump lubricated and cooled by the hydraulic driving oil medium
- Stainless steel pump material
- Concentric hydraulic pipes for maximum safety
- Cofferdam, ventilated to atmosphere, protecting the entire pump
- Mechanical seal against hydraulic oil
- Double-lip seal against cargo, only exposed to static pressure
- Anti-rotation brake – loading through pump
- Smooth pump exterior – self-draining and easy to clean

Performance

The Framo cargo pump is easy to operate. The hydraulic drive provides for remote and local stepless capacity control through the Speed Torque Control (STC) valve on the pump's top plate. The cargo pump can pump anything liquid, regardless of specific weight or viscosity.

It is impossible to overload or overspeed the pump. The STC valve automatically regulates hydraulic oil pressure and flow to the hydraulic motor according to the given discharge situation

The pump design allows operation with a minimum of liquid in the tank, which saves time spent on drainage and tank cleaning. The Framo cargo pump has an efficient built-in stripping system.



Framo cargo pump

Safe operation

Dangerous chemicals, acids, oils or edibles must be handled in a safe way for people and the environment. The tanker must be equipped with cargo pumps that can efficiently empty cargo tanks and associated cargo piping to meet the most stringent requirements, and withstand the tough impact during hours of tank cleaning afterwards. Switch between cargoes without cargo contamination. Carry anything from acids to drinking water.

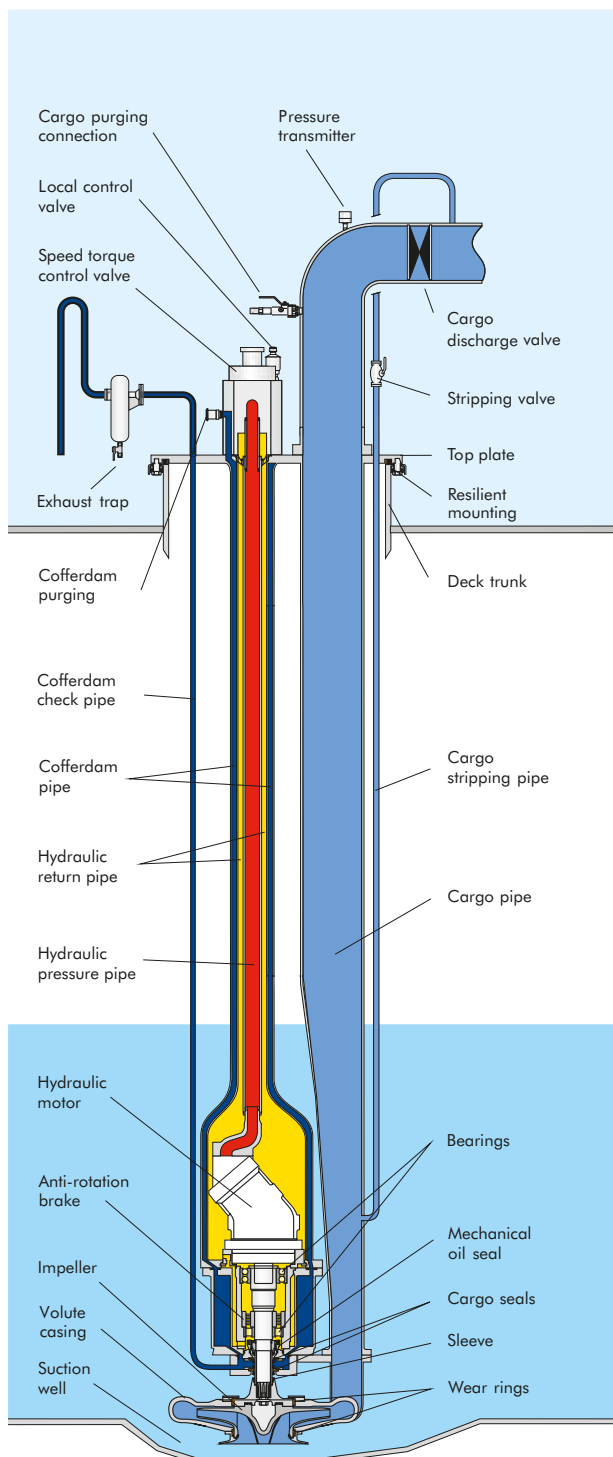

The hydraulic high-pressure pipe is located inside the low-pressure return oil pipe. The entire hydraulic section is separated from the cargo by a cofferdam ventilated to atmosphere.

Condition-based maintenance

Seal monitoring is performed from the cargo pump top plate by purging the cofferdam. Replacement of wear and tear parts is easily handled from inside the tank without interfering with the hydraulic section.

Cargo heating

Framo deck-mounted cargo heaters

Framo deck-mounted cargo heaters eliminate the need for in-tank heating coils. The cargo tank interior can be made with a flush tank top free from coils, brackets and clamps. A flush tank top facilitates quicker stripping with less cargo remaining in the tank. The cargo tank washing can be performed quicker, with less consumption of washing water and less slop handling.

Design features:

- Made for a tough marine environment
- Stainless steel
- Compact welded-plate-type design
- Large heating surface
- Low pressure drop
- Vertical self-draining
- Easy cleaning
- Easy inspection
- Exposure to cargo only when in use

Performance

Framo deck-mounted cargo heaters provide high flexibility to heat all traded cargoes, such as heavy fuel oils, oil products, palm oils and other chemicals that may be temperature-sensitive and require a gentle heating procedure. The specially shaped heating elements secure easy cargo circulation and have a low surface temperature against the cargo.

The high capacity and low pressure drop through the cargo heater results in low power consumption during circulation and secures good mixing and heat distribution inside the cargo tank. The heating medium can be saturated steam, hot water or thermal oil.

A Framo deck-mounted cargo heating system is supplied as an integral part of the cargo pumping system for all sizes of oil tankers, chemical tankers and FPSOs.



Framo cargo heater

Gentle and even cargo heating

Cargo is circulated through the deck-mounted cargo heater, whose heating capacity can be adjusted to meet cargo requirements. The cargo is heated gently with a careful temperature increase across the heater, and the high circulation of the cargo flow ensures good heat distribution inside the cargo tank.

Ballast water pumping

Framo submerged ballast pumps

The installation of ballast pumps inside the double side ballast tanks in combination with a submerged cargo pump in each cargo tank makes the pump room superfluous. This arrangement creates a safer ship design and makes more space available for carrying cargo. Submerged ballast pumps have become the standard arrangement in modern tankers and FPSOs. The pumps are normally installed inside two of the

double side ballast tanks located aft of the manifold area, one in each side. On oil tankers, a fuel-oil tank can separate the engine room and cargo section.

- No pump room required
- Larger volume available for cargo



Framo submerged ballast pump

Anti-heeling

Framo anti-heeling system

The Framo anti-heeling system is an independent and reliable anti-heeling pumping system for loading and unloading operations on container, RoRo, ferry and cruise vessels. It responds instantly to variations in load conditions, starting automatically if the heeling angle

exceeds a set value and continuing until the vessel returns to a preset position. Pre-heeling can be done to compensate for extensive heeling moment.



Framo anti-heeling pump

Piping

Framo hydraulic piping

The need for quality hydraulic installation on board vessels operating in severe marine environments has led to the development and manufacture of Framo hydraulic piping systems. The hydraulic piping systems are based on high-quality components and piping materials.



Framo piping



Heat and cold are fundamental opposites. Mediating between them is a necessary part of onboard operations, and Alfa Laval has a long history of streamlining this exchange. As our innovative solutions grow smaller and more efficient, we continue to redefine the norm.



Cooling and heating

Leading thermal expertise

Heat exchangers are a mature technology, yet Alfa Laval is still pushing limits. Having led the shift from yesterday's heat exchangers to today's compact and energy-efficient solutions, we continue to lead with new techniques, such as laser welding and 100% stainless steel brazing in our plate heat exchangers (PHEs).

Our innovations, which optimize heat transfer and minimize fouling, do more than reduce the size of the heat exchanger. By minimizing losses, they maximize cooling capacity and the availability of cheap heat energy.

Innovations in heat exchanger design

Over the years, our R&D has produced major design advances. Our optimized PHE plate patterns, including the brand new pattern of the Alfa Laval T35 heat exchanger, are an excellent example. And by fine-tuning tube construction and placement, we've increased the durability and flexibility of shell-and-tube models as well.

Similar advances have been made in our gaskets, from specialized elastomers to efficient clip-on constructions like our new ClipGrip™ system. And as time goes on, there will be more advances to come.

Engine and auxiliary cooling

Gasketed plate heat exchangers

Alfa Laval gasketed plate heat exchangers (PHEs) are available in a diverse range of models and configurations to suit key cooling applications. Their stress-resistant plates, which are created in a single pressing from titanium or stainless steel, feature precision-designed patterns that ensure even flow distribution and optimal turbulence. The plates themselves are suspended in a robust frame with either a five-point alignment or perpendicular corner guidance system, which retains their position even through multiple openings and closings. Proper alignment is also secured by the high-quality gaskets, which are manufactured to exact tolerances and easily mounted with our ClipOn or unique ClipGrip gasket mounting system.

- High thermal efficiency that minimizes the number of plates
- Even flow distribution and heat transfer across the plates
- Purpose-designed gasket elastomers
- Easy gasket mounting with the ClipOn or ClipGrip system

- Reliable five-point alignment system
- Robust frames with optimized thickness and low weight

Applications:

- Central cooling
- Lube oil cooling
- Jacket water cooling

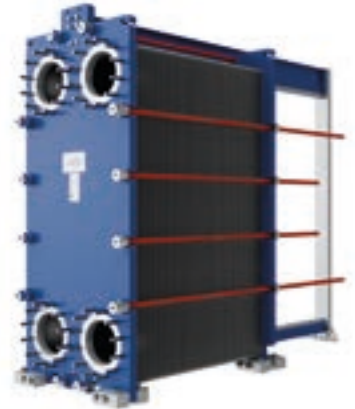

Alfa Laval T35

Energy-saving efficiency

The CurveFlow plates introduced with the Alfa Laval T35 gasketed plate heat exchanger have a cutting-edge design with a patented new pattern and distribution area. They yield a heat exchanger with more effective heat transfer area in relation to its size, which means a smaller investment. Running costs are lower as well, due to a lower pressure drop that reduces pumping costs by up to 20%.

Steam heating and condensing

TS M and AlfaCond gasketed plate heat exchangers

Gasketed plate heat exchangers (PHEs) from the Alfa Laval TS-M and AlfaCond series are specially engineered for steam heating and condensing applications. With their unique plate geometry, strong plate design and heat-resistant gaskets, they withstand the demands of both temperature and pressure. Moreover, their effective heat transfer allows for a reduction in cooling flow rate, which means a lower pump investment and reduced energy cost. They even create a major space savings, since their design is far more compact than the shell-and-tube models previously used in these applications.

- Reduced operating costs
- Ease of maintenance and shorter downtime
- High turbulence, little fouling
- Efficient sub-cooling
- Small footprint
- Extendable design for easy capacity increases
- Stainless steel and titanium models available

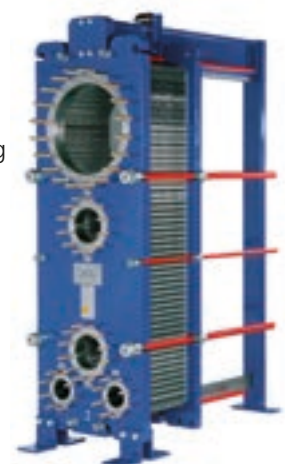

Alfa Laval AlfaCond 600

Gas handling

AlfaRex welded plate heat exchanger

Lightweight and up to 80% smaller than traditional shell-and-tube heat exchangers, the gasket-free Alfa Laval AlfaRex plate heat exchanger (PHE) is suitable for duties involving high temperatures, high pressures and aggressive media. The AlfaRex is laser-welded in only two dimensions, which allows it to resist fatigue by contracting and expanding freely along its length. Its close temperature approach creates lower operating costs and significant lifecycle savings by minimizing power consumption in condensation duties, where less compression of boil-off gas is needed.

- Temperature range from -50°C to +350°C and pressure capabilities up to 40 bar(g)
- Compatibility with liquids, gases and mixtures of liquids and gases (two-phase flows)

AlfaNova M fusion-bonded plate heat exchanger

The gasket-free Alfa Laval Alfa Nova M plate heat exchanger (PHE) features both plates and brazing of 100% stainless steel. Intended for use as an indirect cargo condenser and/or heater aboard LPG/E carriers, it is also ideal for many other gas system duties as a result of its wide temperature range and copper-free construction. Lighter and smaller than traditional shell-and-tube or welded condensers, the Alfa Nova M has a lower condensing pressure and increased condensing capacity, which means tangible energy savings and reduced turnaround time in port. Its

Performance saves energy and time

Due to superior heat transfer characteristics compared to traditional heat exchangers, the AlfaNova M enables lower condenser pressures. This results in lower compressor energy consumption in the LPG reliquefaction system. Alternatively, the condensing capacity can be increased, which in turn reduces compressor operating time.

- Low hold-up volume
- Laser welding that reduces the heat-affected zone and stress build-up in the plates

Applications:

- LPG condensation
- Evaporation/condensation of clean fluids
- Refrigeration
- Cargo heating liquid
- General heating/cooling with high pressures or temperatures



Alfa Laval AlfaRex

innovative stainless steel construction is adapted from the proven AlfaNova series, which combines brazing filler of stainless steel with Alfa Laval's patented fusion technology, AlfaFusion™.

- Ideal cargo condenser for indirect LPG reliquefaction systems
- Fresh water or glycol solution as cooling medium
- Compatibility with all LPG media, including ammonia
- Leakage protection – gas cannot enter the seawater loop
- Same low weight and high efficiency as copper-brazed heat exchangers
- Superior temperature range between -196°C and +550°C
- Weight: 400 kg
- Footprint: 0.5 m²



Alfa Laval AlfaNova M

Printed circuit heat exchanger (PCHE)

The Alfa Laval printed circuit heat exchanger (PCHE) delivers unparalleled compactness and efficiency in clean and high-pressure duties that are beyond the capabilities of welded plate heat exchangers. Its superior robustness and integrity allow design pressures from vacuum to 650 bar(g), yet it is 80% smaller and lighter than traditional shell-and-tube heat exchangers. The PCHE's unique design results in not only excellent performance and an exceptionally high heat transfer rate, but also improved safety and savings in installation and operation. Each unit can be fully customized according to the exact needs of the customer.

- Excellent performance in high-pressure LNG heat transfer duties
- Exceptional savings in footprint, volume, weight and structural support costs
- Exceptionally high heat transfer rate for maximum operating efficiency
- Very wide capacity range
- Full customization of fluid channel pattern enabled by diffusion bonding
- Design temperatures from cryogenic to 800°C
- Design pressures up to 650 bar(g)



Alfa Laval printed circuit heat exchanger (PCHE)

Electric heating

Aalborg EH

The Alfa Laval Aalborg EH is a flow-through electric heater, ideal for heating either oil or water. Primarily used as a booster heater, it has a flexible design that makes it well suited where electric power is the least expensive or only available power source. The standard model is mounted either vertically or horizontally. In addition, there is an Aalborg EH-S model, which can serve as an alternative to boiler conversion for MGO operation.

- Capacity: 3-235 kW
- Design temperatures: up to 160°C
- Design pressures: up to 16 bar(g)
- Construction in carbon steel or stainless steel (AISI 316 or better)
- Vertical or horizontal mounting
- Type approval from major classification societies

Accessories (optional):

- Valves
- Monitoring equipment
- Regulating equipment



Alfa Laval Aalborg EH

MGO use without conversion

The Aalborg EH-S model, which is a complete unit with control cabinet, pre-mounted pump, safety valve and non-return valve, can be connected to an auxiliary steam boiler instead of converting it for MGO operation. This allows environmental compliance with EU directive 2005/33/EC.

Oil and water preheating

Aalborg MX

Compact Alfa Laval Aalborg MX shell-and-tube heat exchangers are most frequently used as oil preheaters for main and auxiliary engines, burners and separators, though their flexible design can be customized to almost any application. Comprised of U-formed tubes with a small diameter, they use either steam or thermal oil as a heating medium. Aalborg MX models are available for use as insert/immersion heat exchangers, as well as for use as outflow suction heaters.

- Capacity: 10-2000 kW
- Design temperatures (shell/tube): up to either 160/204°C or 195/212°C
- Design pressures (shell/tube): up to 16/16 bar(g) or 32/19 bar(g)
- Construction in carbon steel (other materials upon request)
- Baffles and nozzles tailored to individual requirements and acceptable pressure drop
- Type approval from major classification societies

Accessories (optional):

- Valves
- Monitoring equipment
- Regulating equipment



Alfa Laval Aalborg MX

Dump condensing and tank cleaning

Aalborg MD

Constructed from noble materials, Alfa Laval Aalborg MD shell-and-tube heat exchangers are extremely resistant to seawater and therefore require no sacrificial anodes. This makes them an ideal solution for use as dump condensers, drain coolers, oil coolers or heaters for tank cleaning fluid. Available in designs for either atmospheric or pressurized operation, they feature straight tubes in CuNi and an externally sealed floating tube sheet that compensates for thermal expansion.

- Capacity (condensing): up to 6000 kg/h steam at 3 bar(g)/157°C, subcooled to 90°C with 32°C seawater
- Capacity (tank cleaning): up to 360 m³/h seawater, heated from 5°C to 80°C
- Design temperatures (shell/tube): up to 204°C/100°C
- Design pressures (shell/tube): up to 16/16 bar(g)
- Construction in CuNi 90/10 or CuNi 70/30 alloy, Al/Ni bronze, and carbon steel
- Type approval from major classification societies



Alfa Laval Aalborg MD

Accessories (optional):

- Valves
- Monitoring equipment
- Regulating equipment

Oil and chemical heating

Aalborg MP-C

Built with over 30 years of cargo heating experience, Alfa Laval Aalborg MP-C shell-and-tube heat exchangers are constructed in 100% stainless steel (AISI 316L) and are thus a perfect choice for heating oil, corrosive or edible cargo. Their heating surfaces are optimized through the use of specially designed baffle plates, which results in a very compact, efficient and cost-effective installation. Horizontal or vertical mounting is possible, and steam, thermal oil or hot water can be used as a heating medium.

- Standard capacity: 250-2000 kW (other capacities upon request)
- Design pressures (shell/tube): up to 14/10 bar(g)
- Construction in stainless steel (AISI 316L)



Alfa Laval Aalborg MP-C

Accessories (optional):

- Valves
- Monitoring equipment
- Regulating equipment

Oil and water heating and cooling

CBM

Virtually maintenance-free, the Alfa Laval CBM plate heat exchanger has a compact and cost-effective design that is easy to install or retrofit, even in confined spaces. It comprises corrugated steel plates held together with copper brazing, which ensures optimal heat transfer efficiency and pressure resistance. The CBM covers a large range of applications and can be tailor-made for a particular duty, with various connection standards and connection sizes of 30-100 mm.

- Low-cost investment
- Optimum use of space
- Minimal maintenance – no replacement parts

In addition, there is a preconfigured solution known as the HEATPAC® CBM, specially designed for the heating of mineral oil prior to separation. The HEATPAC CBM, which is available with two connection sizes and with 20, 40, 60, 80 or 100 plates, is able to handle duties up to 30 m³/h.

Compatible media:

- Water
- Oil
- Steam
- Thermal oil
- Glycol solution
- Most refrigerants



Alfa Laval CBM400

Alfa Laval
HEATPAC® CBM

Filtration

Automatic self-cleaning filter, ALF

Simple and cost-effective to install, the automatic self-cleaning filter protects a plate heat exchanger by removing debris at the seawater intake. Installed between the seawater pumps and the PHE itself, it provides continuous filtration of the cooling water. Collected debris is automatically removed without disrupting the liquid flow. The filter is easy to service, since the filter basket can be removed without removing the pipes.

- Prevention of PHE clogging
- Continuous, automatic cleaning process
- Short flushing period with flexible regulation of flushing intervals
- Low pressure drop
- Easy service without removing pipes
- Electrical, pneumatic or hydraulic actuators

Available in two models:

- ALF-S (stainless steel)
- ALF-R (rubber-lined carbon steel)



Alfa Laval ALF

Port filter

The port filter is a low-cost alternative to the Alfa Laval ALF filter. Installed in the seawater inlet port of a plate heat exchanger, it prevents the PHE from clogging with debris that may have passed through the main seawater intake filters/strainers. Removal of the port filter for maintenance is performed from the pressure plate side of the PHE, which means that dismantling of the inlet pipework is avoided.

- Materials: Alloy 254 (for seawater), titanium, Alloy 316L
- Standard mesh size: Ø 1.5-2.2 mm Δ corresponding to open surface of 37%

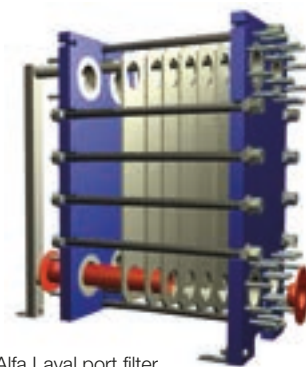

Alfa Laval port filter

Cleaning-in-Place

Cleaning-in-Place (CIP) systems for heat exchangers

Alfa Laval Cleaning-in-Place (CIP) systems are a simple way to keep heat exchangers of all types performing optimally. Connected directly to the heat exchanger ports, they circulate heated, usually biodegradable fluids that effectively dissolve scale, sludge and microorganisms. In this way, the fouling that reduces heat transfer can easily be removed without any need to dismantle the heat exchanger. Not only does this save time on cleaning, it helps to prolong plate and gasket lifetimes.

- Easy operation
- Prolonged gasket life – no damage
- Heating of cleaning fluids with electricity or steam
- Compatibility with spiral, shell-and-tube, gasketed, welded and brazed heat exchangers
- A range of models and sizes available



Cleaning-in-Place (CIP) fluid for heat exchangers

Alfa Laval Cleaning-in-Place (CIP) fluids for heat exchangers are designed to keep your equipment in peak condition without endangering fragile marine ecosystems. All of the fluids are non-hazardous, and many of them are also biodegradable. Most gentle is the general-use line of Alpacon fluids, which contain a unique raw material based on fermented whey.

Safe and natural ingredients

Alfa Laval's high-performance fluids for Cleaning-in-Place (CIP) systems are non-hazardous, which means that no health risks are posed and no protective equipment is necessary. They are also safe for the environment, as they are based to the greatest possible extent on gentle, natural ingredients.

Fluids for general use:

- Alpacon Descalant
- Alpacon Degreaser

Fluids specific to heat exchangers:

- AlfaPhos
- AlfaCaus
- AlfaNeutra
- AlfaAdd

Water is the most abundant substance at sea, but the salt and impurities seawater contains make it unsuitable for most purposes on board. Alfa Laval's freshwater generators let you take economical advantage of this resource and do away with expensive, low-quality bunker water.



Desalination

Smarter ways to fresh water

Alfa Laval pioneered the compact and cost-efficient production of fresh water. Over 50 years ago, we introduced thermally driven freshwater generators with dual-plate-pack technology. These were not only smaller than shell-and-tube installations, but also far less sensitive to scaling.

Today we've further developed our plate concept, enabling vacuum distillation within a single plate pack. Our Alfa Laval AQUA Blue freshwater generator, which houses the vacuum in the plate pack itself, contains revolutionary three-in-one titanium plates on which evaporation, separation and condensation all occur.

Reducing energy use and emissions

A major advantage of the three-in-one AQUA plate technology is the fact that it cuts seawater requirements in half. This allows smaller pipes and pumps to be used, which means a reduced initial investment, easier installation and lower energy consumption – with lower CO₂ emissions as a result.

But the energy efficiency is hardly limited to AQUA Blue. Where larger volumes of fresh water are needed, our Alfa Laval multi-effect plate (MEP) desalination plant typically consumes just 1.3-3.0 kWh/m³, thanks to an optimized pump configuration and a frequency-controlled motor on the seawater pump.

Seawater desalination

AQUA Blue

The Alfa Laval AQUA Blue freshwater generator utilizes Alfa Laval's pioneering AQUA plate technology. As a result, it uses just half the pumping energy of other freshwater generators – because it requires only half as much seawater. Distillation occurs in a single plate pack, assembled from a single type of purpose-built titanium plate. In AQUA Blue, this technology is combined with a wide range of enhancements for easier installation and simpler operation. Minimal maintenance is required, and the plate pack slides open for easy access to the interior without an additional service area.

- 3-in-1 plate technology (evaporation, separation, condensation)
- Half the seawater pumping needs of other freshwater generators
- Energy-efficient IE3 motor
- Intuitive operator interface



Alfa Laval AQUA Blue

- Robust construction with duplex piping
- Simple, compact installation with less investment
- Optional high-pressure capabilities
- Max. salinity: 2 ppm
- Capacity: 2-60 m³/24 h

Less fuel used for pumping

Because the AQUA Blue freshwater generator requires only half the seawater flow of other freshwater generators, pumping requirements are cut by 50%. This allows smaller seawater pumps to be used, and it means that the pumps consume less electric power. Since energy on board ultimately comes from the burning of fuel, this means a positive affect on both fuel consumption and CO₂ emissions.

Optional high-pressure configuration

Jacket water often provides the heat for desalination, and today's jacket water pressures are frequently higher than 4 bar. There is thus a high-pressure option for AQUA Blue. This high-strength configuration performs aboard large vessels with deep draft and provides additional installation flexibility for shipyards.

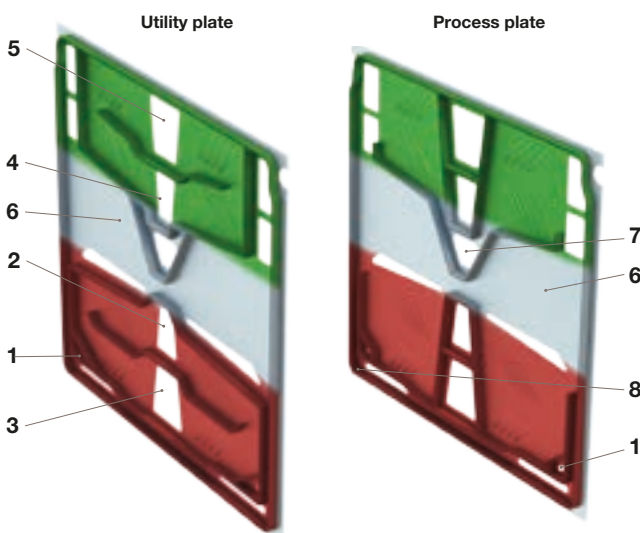

- | | | | |
|---|----------------------|-------|--------------|
| 1 | Seawater feed | | |
| 2 | Heating medium in | Green | Condensation |
| 3 | Heating medium out | Grey | Separation |
| 4 | Seawater cooling in | Red | Evaporation |
| 5 | Seawater cooling out | | |
| 6 | Evaporated vapour | | |
| 7 | Fresh water out | | |
| 8 | Brine out | | |

Multi-effect desalination plant (MEP)

The Alfa Laval multi-effect plate freshwater generator (MEP), is capable of generating large volumes of high-quality fresh water for domestic and technical use. Using waste heat from the engines or low-pressure steam as a heat source, the MEP distils seawater by means of titanium plate heat exchangers that are integrated into the evaporator/condenser chambers. Each MEP is custom-designed for a specific installation using the highest-grade materials, which together with the optimized process design ensure the highest reliability, the least downtime, and the longest and most economical service life.

- Low production cost
- State-of-the-art and user-friendly control technology
- Fast start-up and quick response to load changes
- Titanium plates that resist seawater corrosion
- Patented plate design and falling film process for high thermal efficiency
- Unique construction that allows direct access to heating surfaces
- Evaporator vessel of AISI 316L steel
- High distillate purity and salinity of 5-10 ppm
- Capacity: 200-1000 m³/24 h per unit

DPU and JWP freshwater generators

Designed for automatic operation, Alfa Laval freshwater generators use vacuum distillation to provide constant fresh water throughout a ship's lifetime. With titanium plates in the heat exchangers and non-ferrous materials throughout, they have a low scaling rate and non-corroding vital parts. Moreover, they require little maintenance and no adjustment once tuned to operating conditions. DPU and JWP models have front-cover accessibility, and the two-stage DPU saves energy by using vapour from the first stage as a heating medium for the second.

- Utilization of jacket water and hot water or live steam in combination with a hot water loop system
- Max. salinity: 2 ppm
- Capacity: DPU series (two-stage):: 20-75 m³/24 h
JWP series (single-stage): 0.5-10 m³/24 h



Alfa Laval multi-effect desalination plant (MEP)

Economical operation

The MEP desalination plant offers the lowest possible consumption of both power and chemicals. The power consumption of the 4-effect MEP-4-750 desalination unit, for example, is less than 2.5 kWh/m³. Moreover, the MEP needs neither a seawater circulation pump nor any anti-foam injection, and its total antiscalant consumption is less than that of traditional MSF units.



Alfa Laval DPU-2



Alfa Laval JWP-16

Water heating and circulation

Hot Water Loop

A complement to freshwater generator systems, the Alfa Laval Hot Water Loop provides the correct amount of heating water at the correct temperature – even when the engine is not running. This facilitates the distillation process and makes maximum use of the freshwater generator's capabilities. Reliable and automatic, the Hot Water Loop can even be used for other onboard heating applications, such as the pre-heating of the main engine during periods of standstill. Its compact, modular design requires little space and ensures a simple, low-cost installation.

- Reliable operation due to self-adjusting steam regulation equipment
- Possibility to use in pre-heating of the main engine or other equipment
- Capacity: 7-100 m³/24 h

Equipment:

- Stainless steel plate heat exchanger with bed frame and internal piping
- Hot water circulating pump, electric motor and starter
- Thermostatically controlled steam / thermal oil regulating valve
- Instruments and steam trap



Alfa Laval Hot Water Loop 35-60

Steam arrangement for alternative operation

For use with the Alfa Laval AQUA Blue freshwater generator, the steam arrangement for alternative operation (HWS) allows the production of fresh water with steam from the vessel's steam boiler as a heat source. This means there can be a backup supply of high-quality technical water when the ship's main engine is not in service, such as when the vessel is at anchor. The steam injector system consists of a steam injector and an arrangement of pipes, instruments and internal valves.



Steam arrangement for alternative operation (HWS)

Water treatment options

Adding water treatment options to your freshwater generator is a way to make immediate improvements in water quality.

Options:

- Filter for pH adjustment
- Chlorination
- Dechlorination
- Ultraviolet sterilizer
- Silver-ion water sterilizer

Local and global regulations concerning exhaust gas emissions have grown significantly tougher in recent years – and will likely become tougher still. Among those affecting the marine industry are regulations that limit emissions of nitrogen oxides (NOx), sulphur oxides (SOx) and particles.



Emission control

Smart strategies for compliance

Vessel emissions can be abated without changing fuels. NOx formation, for example, can be limited by optimizing the combustion process through Exhaust Gas Recirculation (EGR). Alfa Laval has partnered with MAN to develop this technology, in which Alfa Laval PureNOx Prime has a vital role.

Other emissions can be removed effectively after their formation, such as SOx, which is a direct result of the fuel sulphur content. Using a scrubber like Alfa Laval PureSOx, vessels can meet limits in Emission Control Areas (ECAs) while continuing to use economical HFO.

Separation a key component

Alfa Laval's separation expertise is crucial to many abatement strategies. In both EGR and SOx scrubbing, water cleaning by means of a centrifugal separator safeguards the abatement process and enables MEPC.184(59) discharge compliance.

Some emissions can even be removed by the separator itself. Alfa Laval PureVent is a unique separator solution for cleaning the oil and particles from crankcase gas. Mounted directly on the engine, it achieves a cleaning efficiency as high as 99.9%.

Exhaust gas cleaning

PureSOx

Alfa Laval PureSOx is a compact and highly effective scrubber system for removing SOx from exhaust gas. It allows continued operation on high-sulphur fuel while ensuring compliance with legislation in SOx Emission Control Areas (ECAs). As flexible as it is reliable, the PureSOx platform supports a range of configurations to suit the sailing profiles and physical constraints of the majority of vessels. Open-loop and closed-loop scrubbers are possible, as well as hybrid scrubbers with both open-loop and closed-loop modes (see right). Likewise, scrubbers can be built with either a U-design or an inline I-design, depending on vessel needs. When built with a U-design, PureSOx can even be configured with multiple inlets, allowing it to handle exhaust gas from several sources, including the boiler.

- Sulphur removal rate >98% (exceeds IMO requirements)
- Particulate matter (PM) trapping up to 80%
- Open-loop, closed-loop or hybrid configurations (see right)
- U-design or inline I-design
- Multiple-inlet options to reduce the number of scrubbers needed
- Water cleaning with demonstrated results and minimal sludge generation in closed-loop operation (see PureSOx H2O on bottom right)
- Liquid or powder dosing options for closed-loop operation
- Operating power consumption: approximately 1.5% of engine power
- All delivered systems in operation today – more references than any other single SOx scrubber technology
- Many satisfied customers who order again

Continued fuel economy

PureSOx is a win-win solution that benefits ship owners and ship operators as well as the environment. It effectively removes harmful SOx compounds from vessel exhaust before they can reach the atmosphere, which enables continued operation with economical HFO. There is thus no need to switch to more expensive low-sulphur fuel for ECA compliance.

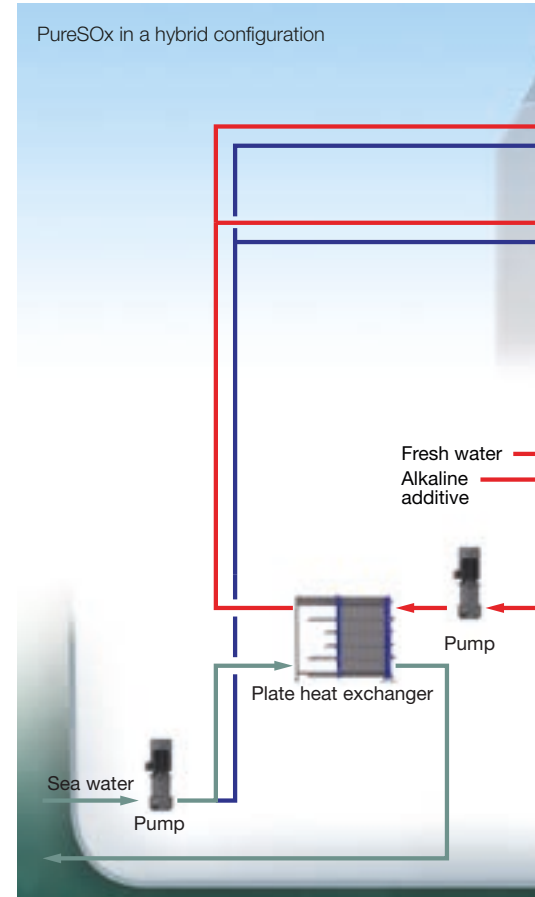

Alfa Laval PureSOx with U-design

Alfa Laval PureSOx with I-design



PureSOx H20

Compact and modular, the Alfa Laval PureSOx H20 water cleaning unit is a vital part of closed-loop and hybrid configurations of Alfa Laval PureSOx (see left). Using centrifugal separation to clean scrubber water in compliance with IMO legislation, it reduces solids content to well below the required 25 FTU – regardless of engine load or sea conditions. This is done continuously, with instant bleed-off and automatic chemical dosing only when necessary. All equipment comes installed and tested on a common frame, which is divided into three modular blocks to simplify retrofitting.

Operating configurations

■ Open-loop

Seawater is used to scrub the exhaust gas, after which it is legally discharged back into the sea. Though the investment and operating costs are lower, use may be limited due to low water alkalinity or local legislation.

■ Closed-loop

The scrubber water is dosed with an alkaline additive and recirculated. As it becomes dirty, the water is cleaned, discharged and replenished to retain capacity. Use is possible anywhere and at any time.

■ Hybrid

Both open-loop and closed-loop modes are readily available. Open-loop operation reduces costs whenever possible, but a switch to closed-loop operation can be made whenever demanded.

PureSOx builds directly on over 40 years of scrubber experience, as well as Alfa Laval core expertise. Both plate heat exchanger technology (see page 24) and centrifugal separation (see PureSOx H20 below) are utilized in closed-loop and hybrid configurations.



Alfa Laval PureSOx H20

EGR water treatment

PureNOx Prime

Alfa Laval PureNOx Prime cleans the circulation water in an Exhaust Gas Recirculation (EGR) process. EGR is an attractive alternative for compliance with Tier III NOx reduction demands, which will apply in the first NOx Emission Control Area (ECA) starting in 2016. Specifically for use with low-sulphur fuel, PureNOx Prime is a streamlined version of the PureNOx water treatment technology, which has been proven in thousands of hours of operation at sea. PureNOx Prime offers not only a significantly smaller footprint, but also a substantially lower investment cost. This adds to the existing advantages of EGR, which include not only compact and easy installation, but also lower operating costs than other Tier III options.

- Well-established solution underpinned by more than 3500 hours of real-world operation at sea
- Cleaning of EGR circulation water for engine protection
- Cleaning, monitoring and logging of bleed-off water in compliance with the IMO directives in MEPC.184(59)
- Control of salt concentration in the EGR circulation water
- Reduced maintenance costs for the EGR system

- Significantly reduced waste volumes for onshore disposal
- Modular construction based on functional blocks
- Compact and simple installation as an integral part of a two-stroke diesel engine
- Installation as separate skids if space requires

Equipment (delivered as a module):

- Water treatment unit (WTU) module with Alfa Laval SWPX separators, ancillary equipment and control cabinet
- Buffer tank unit (BTU) module with buffer tank and control cabinet

Protection of engine and environment

An EGR system recirculates up to 40% of the exhaust gas into the charge air chamber. This lowers the combustion temperature, which directly reduces the formation of harmful NOx emissions. PureNOx Prime not only prevents soot and compounds derived from the exhaust gas from accumulating in the EGR system and corroding the engine, but also enables the bleed-off of clean water in compliance with IMO criteria.



Alfa Laval
PureNOx Prime



Crankcase gas cleaning

PureVent 2.0

Alfa Laval PureVent 2.0 is a newly upgraded separator for crankcase gas cleaning. By using centrifugal separation to remove oil and particles from crankcase gas, it offers an opportunity to further reduce engine emissions. Crankcase gas enters at the bottom of the separator and passes into the disc stack, where centrifugal force presses the oil and soot out between the discs. The virtually oil-free air can then be released into the atmosphere, while the oil that collects on the inside of the PureVent 2.0 housing is recirculated as lubrication or drained off for incineration or deposit.

- Cleaning of crankcase gas and other oily mist emissions
- Internal compatibility for separation of EX Zone 1 oil mist
- 98-99.9% separation efficiency
- Stable pressure maintained in the engine crankcase – whereas filters can clog and change the pressure drop
- Small size – just 30 l
- VFD-controlled operation
- Major service every 16,000 hours or five years, whichever comes first

Oil for recirculation

PureVent 2.0 eliminates oil mist and protects the environment without negatively affecting engine performance. In fact, it allows the recirculation of collected oil as lubrication, which helps to reduce your overall oil consumption. By using centrifugal separation instead of filters, it returns virtually oil-free air without creating waste for disposal.

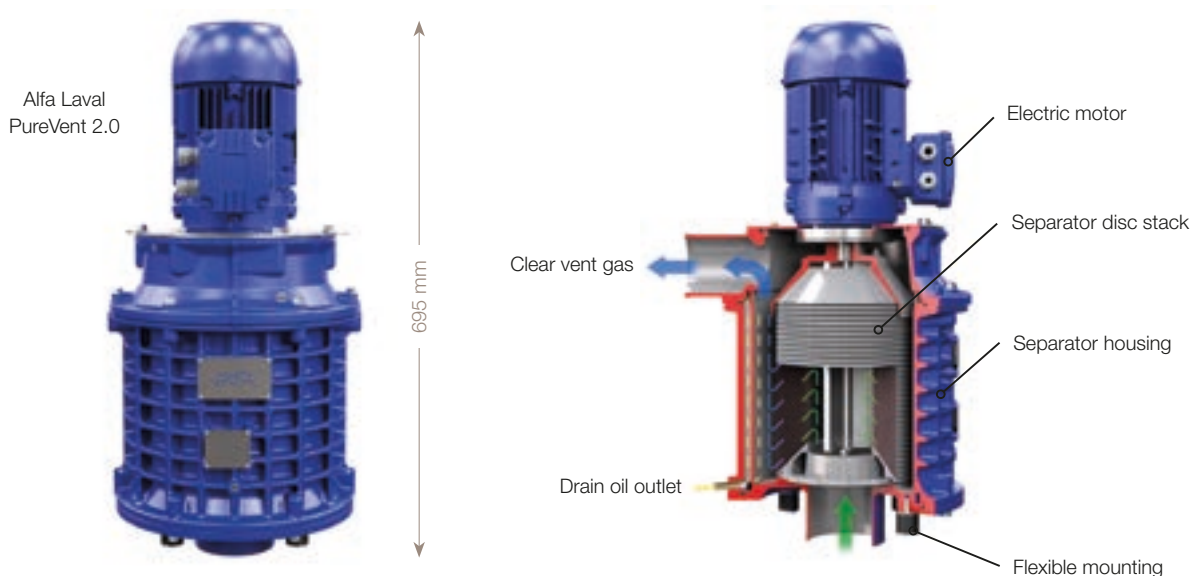



Alfa Laval helps you make the most of your fuels and lubricants. Whether maximizing the energy you get from your fuel or extending the lifetime of circulated oils, our treatment solutions bring you long-term economy while protecting your engine and other sensitive equipment.

Fuel and oil treatment

From separation to full coverage

Alfa Laval separators first opened the door for the fuel oils so common today. That gives us more oil treatment experience than any other marine supplier. Over the years we've reduced the complexity of our equipment, while at the same time increasing its efficiency and the protection it provides.

In addition, we've greatly expanded our equipment's scope. What began with a separator is now a full portfolio of treatment solutions, extending from the bunker tank all the way to the engine.

Taking an adaptive approach

Today we work with the entire fuel line, optimizing it as a process. We adapt separation to the oil's true composition, and we condition the fuel's temperature, pressure and viscosity to match engine specifications. By responding to the engine load, we also enable lower fuel consumption and greater protection against cat fines.

In addition, we're meeting the demands created by a broader range of fuels on board. As well as safeguarding the changeover between HFO and distillates, we're paving the way for tomorrow's low-flashpoint fuels and other alternatives.

Oil cleaning

S and P Flex range

Alfa Laval S and P Flex separation systems are the result of continuous technical development and innovative design solutions. They combine the high efficiency, low sludge output and low operating cost of Alfa Laval self-cleaning centrifugal separators with a truly flexible scope of supply, producing a market-leading solution with many benefits.

Key benefits

■ Optimal performance and highest efficiency

A fine-tuned bowl design ensures optimal performance and the best possible separation efficiency. S separators also feature unique Alcap technology for continuous monitoring of the cleaned oil.

■ High reliability

Advances in internal design, as well as other technical features created with Alfa Laval expertise, increase system reliability and your peace of mind.

■ Easy installation

The small physical size of the separators, combined with the flexible delivery options of the S and P Flex range, simplifies positioning and installation in the engine room.

■ Easy operation and service

The Alfa Laval EPC 60 controller, which is a part of all deliveries, is designed for intuitive menu navigation and “one-button” starts and stops. Its modular construction enables faster troubleshooting and I/O board replacement.

■ Lowest lifecycle cost (LCC)

Alfa Laval separation equipment offers the lowest oil losses, lowest power consumption, least maintenance and fewest wear parts on the market. With Alfa Laval, you are thus ensured the lowest LCC and the shortest payback time on your equipment investment.



Optimized Alfa Laval separator bowl

High efficiency and less sludge

Alfa Laval S and P separators have optimized bowls and other design features that lead to exceptional efficiency. No matter which model you choose, you can count on low water consumption, low energy consumption and low oil losses. All this means less sludge to dispose of and a reduced burden on the environment.

Certified separation performance

Alfa Laval S900 separators are CFR (Certified Flow Rate) tested and certified according to the marine Separation Performance Standard, CWA 15375. Ensuring the reduction of harmful cat fines to acceptable levels can significantly improve the quality of the fuel oil injected into the engine, thus minimizing the risk of engine wear and breakdown.

Low-wear mechanical platform

S separators 921-987 and P separators 626/636 are built on a low-wear mechanical platform that features CentriShoot and CentriLock. The CentriShoot discharge system, which greatly reduces sludge volumes, has a fixed discharge slide that flexes gently to expose the discharge ports, thereby eliminating metal-to-metal wear. The CentriLock bowl-locking system uses a lightweight, non-threaded snap ring that prevents wear by allowing easy removal without a sledgehammer.



S separators

Alfa Laval S separators feature Alcap technology, which means they are particularly suitable for cleaning heavy fuel oils and other residual oils of high and varying density. Based on a measurement of water content in the clean oil outlet, they automatically adjust the oil/water interface within the separator bowl.

- Compatibility with all fuel and lubricating oils
- Oil densities up to 1010 kg/m³ (Alcap)
- Viscosities up to 700 cSt/50°C (higher on request)
- Minimal sludge volumes and oil losses
- Performance monitoring in full flow via water-in-oil monitor

P separators

Alfa Laval P separators are designed to handle uniform oils of consistent and lower densities, such as lubricating and marine diesel oils. Because they utilize purifier technology, in which the separation level is set with a gravity disc, they do not automatically compensate for density fluctuations.

- Compatibility with lubricating, distillate and light marine fuel oils
- Oil densities up to 991 kg/m³
- Viscosities up to 700 cSt/50°C (higher on request)
- Low sludge volumes and oil losses

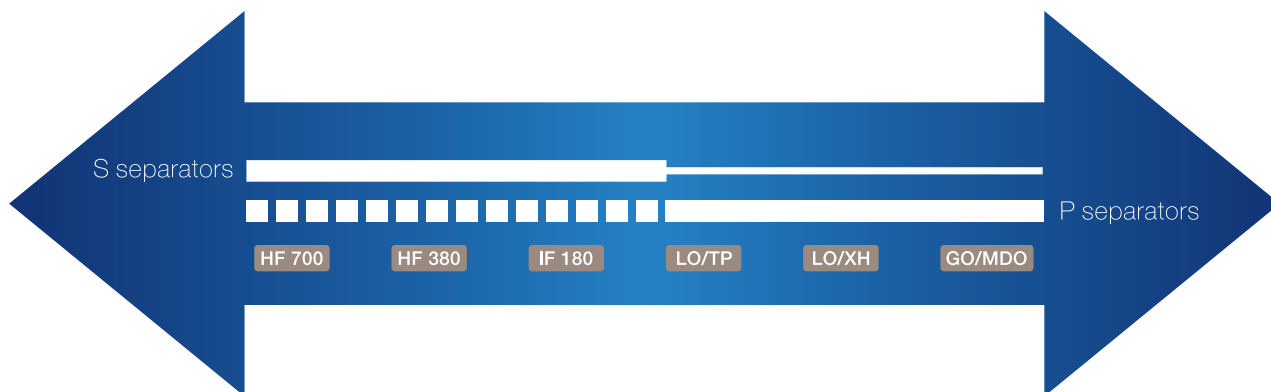

Waste fuel recovery

The introduction of MEPC.1/Circ.642 allows the HFO fraction of waste fuel oil to be recovered and reused as fuel for the diesel engines. This makes it advantageous to use Alfa Laval PureDry (see page 59) after fuel cleaning with the S separator. PureDry returns up to 2% of the consumed fuel oil to the fuel oil bunker tank, which results in tangible fuel cost savings. In the process, it reduces the S separator's already small waste volumes by 99%, leaving only super-dry solids and sending water with an oil content of less than 1000 ppm to the bilge water treatment system.

Lifecycle cost considerations

Typical lifecycle cost (LCC) over 20 years

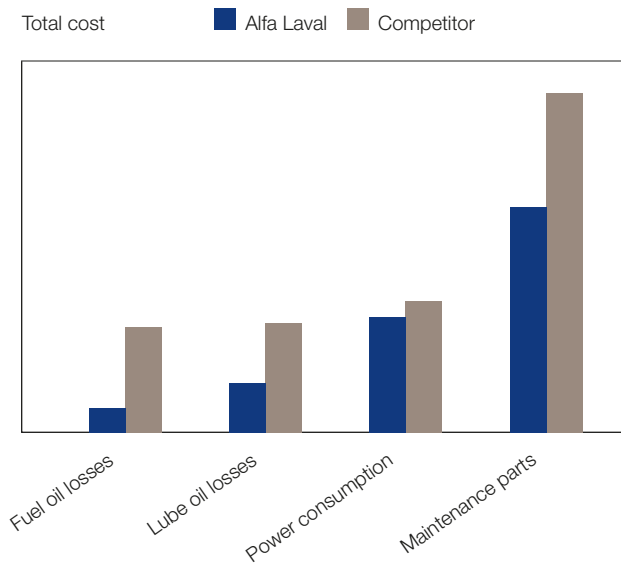

Accumulated cost over 20 years

Accumulated cost

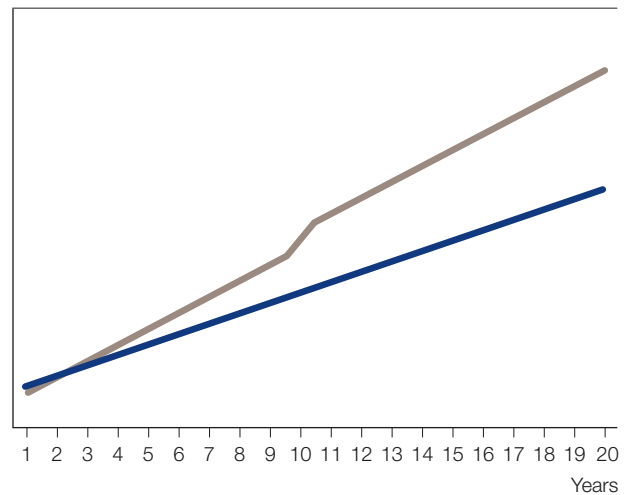

The graphs above are examples of typical lifecycle cost. As the graphs indicate, the investment cost only represents a small part of the lifecycle cost. Energy-related costs and maintenance costs are far greater, which means that investing in an efficient separator quickly becomes very profitable. To find out how much you could save, please contact your local Alfa Laval representative to make your own LCC calculation.

Flexible supply



■ Flex system

A separator with ancillaries in the form of optimized block components provides full say over the use of space. This allows for local modularization or do-it-yourself assembly.



■ Flex modules

A compact separator module can be built to a customer specified configuration from a wide range of skids and machine blocks. Multi-modules and mixed modules are possible for the simultaneous treatment of different types of mineral oils.



Alfa Laval
MMB 305

935 mm

MMB and MAB

Robust, compact and easy to install, the manually operated Alfa Laval MMB and MAB separator systems are ideal for applications aboard coastal vessels, work boats, fishing vessels, ferries and yachts. Complete systems for purifying or clarifying mineral oils, they feature simple operation and a large sludge space, which extends the operating period between manual cleanings. The MMB system is also belt driven and features an internal paring disc for discharge of clean oil.

- High serviceability
- Proven equipment with low maintenance and spare parts consumption
- Compatibility with lubricating, distillate and diesel oils (MDO)



Alfa Laval
MAB 103B

565 mm



MIB 303

The low-maintenance Alfa Laval MIB 303 operates as a purifier for distillate and marine diesel oil, and as a purifier or clarifier for lubricating oil. An excellent solution for oil cleaning aboard smaller vessels, its compact design allows for plug-and-play installation in very confined spaces. The MIB 303 removes solid impurities and reduces the risk of bacterial growth in the tanks, thereby extending the interval between filter replacements and cutting costs.

- Compatibility with oils possessing a maximum density of 920 kg/m³ at 15°C
- Max. separation temperature: 70°C
- Capacity: 760 l/h of diesel/gas oil
Max. 460 l/h of lubricating oil

Mobile hydraulic oil cleaning system, Emmie
Wheeled from tank to tank and “installation free”, the Alfa Laval Emmie cleaning system protects against hydraulic system failure by removing water and particles from hydraulic oil. This has the added benefit of extending hydraulic oil life and reducing filter cartridge consumption. The Emmie system takes its power from a standard 230V AC wall socket, and it requires only a brief cleaning at regular intervals. It comprises a stainless steel trolley with mounted separator, variable-speed pump, tank and control box, plus an electrical preheater and a set of quick-release hydraulic hoses.

- Removal of water and 99% of all particles in the 2-5 µm size range
- Standard delivery with bowl options for both purifier and clarifier modes

Areas of use:

- Bow, stern and azimuth thrusters
- CP propellers
- Deck cranes, winches
- Hoistable decks, ramps, hatch covers
- Steering gear
- Stabilizers
- Hydraulic lifts
- Deep well pumping systems for product/chemical tankers
- Stern tube lubricating oil
- Thermal oil



Alfa Laval Emmie

HEATPAC® EHS-71

The Alfa Laval HEATPAC EHS-71 is an automatic electric heating system (EHS) suitable for all types of marine mineral oils. It can be used for heating oils prior to centrifugal separation, for example when steam production is low due to slow steaming, or for tank heating when the tank design and operation requires fuels to be stored in unheated tanks. Compact and lightweight, the HEATPAC EHS-71 features specially designed heating elements that provide high-efficiency heat transfer and gentle treatment. Its instant-response electronic temperature control, which has an accuracy of $\pm 1^\circ\text{C}$, safeguards the oil against quality degradation.

- Compact and lightweight design
- Easy installation
- Opposing oil inlet and outlet on same level to enable serial installation
- Gentle treatment
- No deterioration of heated oil
- Rapid response to any load change
- Automatic, start-and-forget operation



Alfa Laval HEATPAC EHS-71

HEATPAC® EHS-72

The Alfa Laval HEATPAC EHS-72 is an automatic electric heating system (EHS) suitable for all types of marine mineral oils. It is particularly suited to heating viscous high-density fuel oils, sensitive lubricating oils and turbine oils prior to centrifugal separation, but it can also be utilized as a heater in booster systems when necessary. Compact and lightweight, the HEATPAC EHS-72 features specially designed heating elements that provide high-efficiency heat transfer and gentle treatment. Its instant-response electronic temperature control, which has an accuracy of $\pm 1^\circ\text{C}$, safeguards the oil against quality degradation.

- Compact and lightweight design
- Easy installation
- Opposing oil inlet and outlet on same level to enable serial installation
- Gentle treatment
- No deterioration of heated oil
- Rapid response to any load change
- Automatic, start-and-forget operation



Alfa Laval HEATPAC EHS-72

Cleaning-in-Place (CIP) system for separators

An Alfa Laval Cleaning-in-Place (CIP) system is a simple and effective way to increase separator performance and lower costs. It hooks up to the separator directly, cleaning the bowl, oil inlets and oil outlets without any dismantling. Not only does this save man-hours, it lowers spare parts consumption since there is no extra wear or damage due to disassembly. In particular, it protects against scratches to the bowl discs that can result from manual cleaning with improper tools, which would otherwise quickly cause the discs to become dirty again. The CIP system, which can also be used to clean Alfa Laval CBM heaters in steam applications, uses water-based cleaning fluids that contain a non-hazardous, organic acid mixture.

- No need for manual cleaning of bowl interior – reduced workload for crew
- No scratching of bowl discs due improper tool use during manual cleaning – discs stay cleaner longer
- Improved separation efficiency due to cleaner bowl
- Same cleaning fluid for both lubricating oil and fuel oil separators



Alfa Laval CIP type 10M

Cleaning-in-Place (CIP) fluid for separators

Alfa Laval Alpacon Multi CIP II is designed for use in a Cleaning-in-Place (CIP) system for separators. It primarily cleans the bowl discs, which maintains separation efficiency and thereby secures the flow of clean oil to the engine. In addition, the fluid maintains the cleanliness of the bowl inlet and outlet. Alpacon Multi CIP II has superior cleaning characteristics and creates no emulsions, which means it does not interfere with the bilge water system. Likewise, it does not lead to corrosion or affect any of the sealing materials used in Alfa Laval separators.

Fluids for general use:

- Alpacon Descalant
- Alpacon Degreaser

Fluid specific to separators:

- Alpacon Multi CIP II (5 l)

Safe and biodegradable formula

Alfa Laval's high-performance Alpacon chemicals are non-hazardous and readily biodegradable.

Adaptive feed control

FlowMate

Alfa Laval FlowMate is an automatic separator feed pump control system for use in fuel treatment. It simultaneously manages and optimizes the operations of all fuel separators on board, reducing their fuel oil feed to match the engine's fuel consumption. At the same time, it monitors and ensures that the daily service tank is filled to a safe working level. FlowMate saves energy by avoiding a situation common in slow steaming, in which clean oil is recirculated from the day tank to the settling tank, only to be pumped and separated a second time. In addition, it improves separation efficiency by allowing increased fuel retention time in the separator bowl.

- Full separation system management from a single, centralized control panel
- Saved electrical pumping energy during slow steaming – reduced energy costs and carbon footprint
- Increased separation efficiency and reduced cat fine levels in the cleaned fuel oil compared to using separators alone
- Easy integration with all fuel system layouts and configurations
- Reduction of normal fuel-related engine wear
- Easy installation with standardized components
- Easy operation via intuitive Alfa Laval Touch Control

The Alfa Laval adaptive fuel line

FlowMate is part of the Alfa Laval adaptive fuel line, a complete solution for minimizing fuel consumption and maximizing protection from cat fines. Besides automatically synchronizing the feed with the engine load, the adaptive fuel line immediately detects elevated risk or separation efficiency loss, safely and efficiently manages multiple fuels, and recovers waste fuel for reuse. Through slow steaming synergies and groundbreaking technologies, it creates an annual savings potential of around USD 1,000,000.



Alfa Laval FlowMate

Fuel conditioning

FCM One

The Alfa Laval FCM One booster system deals with the complex safety and performance issues associated with today's more varied fuels. It combines the strengths of the original Fuel Conditioning Module with a completely new level of flexibility, including a range of advanced options. Besides conditioning fuel for an exact match of engine specifications, the FCM One can be configured to handle multiple fuels, produce fuel blends and manage fuel changeover through a patent-pending automatic process. The chosen features, including all necessary heating and cooling functions, are integrated into a single module with one controller and a unified algorithm.

- Efficient ramping of viscosity and temperature
- Smooth automatic fuel changeover regardless of engine load
- Tight viscosity control during changeover to/from distillates

- Onboard fuel blending (calculation, mixing, changeover)
- Electronic Fuel Record Book with GPS time stamp
- VFD-based control of fuel supply pumps
- Engine-specific monitoring of fuel consumption
- Fully integrated construction, automation and control

Main equipment (standard version):

- Low-pressure supply pumps
- Oil filters
- Flow transmitter
- Mixing pipe with deaeration function
- High-pressure circulation pumps
- Oil heaters
- Viscosity transducer
- Control cabinet



Alfa Laval FCM One

Safe fuel conditioning

The FCM One uses a patent-pending automatic process for changeover between light fuels, heavy fuels and blends. Heating, cooling and other necessary functions are all found in the same module and steered by one controller. This allows smooth ramping with tight temperature and viscosity control, which ensures an uninterrupted and safe changeover process.

Efficient and flexible fuel conditioning

The FCM One enables flawless handling of fuel parameters in accordance with manufacturer specifications. This ensures not only safe engine operation, but also optimal combustion that reduces emissions. In addition, the FCM One provides the most modern methods of monitoring and documenting fuel use.

Low-Flashpoint (LF) FCM One

The Alfa Laval Low-Flashpoint (LF) FCM One booster system unites the ease of use and safety in process control offered by the FCM One (see page 50) with the new application demands of low-flashpoint fuels such as methanol and LPG. Pumped at significantly higher pressures than traditional fuels, these fuel alternatives exhibit low viscosities, low boiling points and high corrosiveness that pose challenges for traditional fuel conditioning systems. The LF FCM One is designed in full compliance with the demands of two-stroke ME-LGI technology, which secures the best combustion control at the lowest operational cost.

- Design specific to ME-LGI engines, ATEX Zone I
- Automatic start and stop sequences via the graphical touchscreen interface
- Automatic purging sequence that minimizes fuel losses by returning fuel to tanks

- Possibility of VFD-based pump control for minimized energy consumption
- Electronic Fuel Record Book with GPS time stamp
- Flexible module design for minimized footprint and optimal maintenance space in hazardous areas
- Coverage for the full range of engines with LGI technology

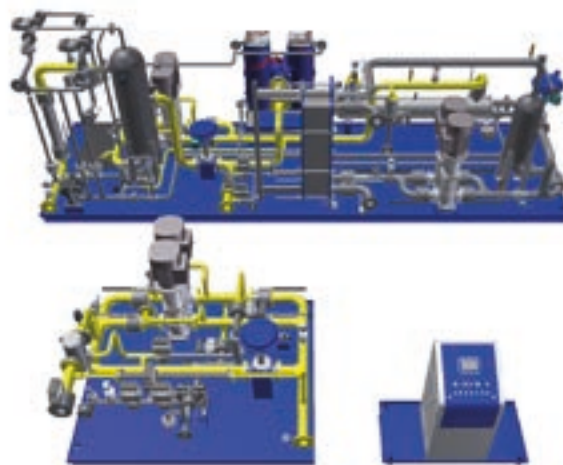

Alfa Laval Low-Flashpoint (LF) FCM One

Gas FCM One

The Alfa Laval Gas FCM One meets fuel conditioning demands when using LNG with engines equipped with high-pressure ME-GI technology. The LNG is pressurized at more than 250 bar and vaporized at cryogenic temperatures using Alfa Laval PCHE technology (see page 26). Alfa Laval automation steers the entire process, which means crews with experience of other Alfa Laval fuel conditioning systems will find it familiar, despite the new fuel requirements.

- Engineering in compliance with ME-GI engines and HiVar® design, ATEX Zone 1
- Automatic start, stop, cooling and purging sequences controlled by Alfa Laval automation
- Smooth, automatic control of fuel pressure for the lowest energy consumption at any load
- Graphical touchscreen interface
- Flexible module design for minimized footprint and optimal maintenance space in hazardous areas
- Lowest possible operating costs for a high-pressure fuel gas supply system

System scope:

- High-pressure pump with high-pressure vaporizer
- Intermediate water heating circuit
- Low-pressure LNG vaporization line
- Gas valve train (GVT)
- Type C tanks (when LNG-fuelled ship design is applied)

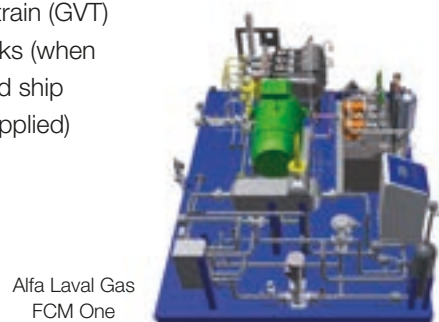

Alfa Laval Gas FCM One

Modular flexibility for wide scope

The Gas FCM One has a modular design to meet the scope of requirements from LNG carriers to LNG-fuelled ships with ME-GI engines, such as container ships and bulk carriers. This includes controlling the LNG conditioning process down to the gas valve train (GVT), with a feeding line for low-pressure DF engines and, when requested, Type C tanks upstream.

Automated Fuel Changeover System (ACS)

The Alfa Laval Automated Fuel Changeover System (ACS) is a safe and optimized way to avoid operational issues during fuel changeover, thus securing engine operation when entering an Emission Control Area (ECA). Fully automatic, it works together with the booster to keep fuel viscosity and lubricity within the parameters set by engine manufacturers. The ACS substitutes a cooling phase for the heating phase in the high-pressure stage of fuel conditioning, which keeps the distillate fuel at a low temperature and maintains safe operating characteristics. Modular and compact, it can be integrated with any new or existing booster installation from any supplier.

- Cutting-edge control of fuel viscosity
- Full compatibility with any fuel booster (tailoring upon request)
- Seamless communication between ACS and Alfa Laval FCM for automatic and reliable changeover
- Support for up to three fuels and different levels of remote control
- Cooling with seawater or fresh water

Viscochief MKII viscosity control system

The Alfa Laval Viscochief MKII is a second-generation viscosity control system for use in fuel oil conditioning systems. It determines fuel viscosity by measuring how much the torsional vibration of a pendulum in the fuel is dampened, a method which ensures the most accurate viscosity measurement. Requiring no special attention during normal operation, the Viscochief MKII can be installed with the EPC50 V controller for both local and remote operation.

- Compact design
- Modern control system and sensor technology
- Electronically controlled pendulum vibration
- Possibility to integrate with ship automation systems

- Direct (HFO → MGO) and intermediate (HFO → MDO → MGO) changeover
- Access to all process parameters for full customization of changeover procedures
- Skid-based module complete with built-in cooler (optional delivery as components)



Alfa Laval Automated Fuel Changeover System (ACS)

Safe and controlled changeover

The use of low-sulphur distillate fuels reduces harmful emissions. However, changing between HFO and these lighter alternatives involves serious operational risks, including potential seize-ups due to thermal shock in fuel pumps. Through controlled and progressive cooling, the ACS protects fuel injection components, maintaining fuel viscosity and lubricity as well as optimal combustion.



Alfa Laval Viscochief MKII

Other available equipment:

- Steam and electric heating systems (can be controlled manually if controller electronics are not functioning)
- Steam regulating valve with remote position indication
- HFO/DO changeover valve

Filtration

Automatic full-flow filters

Alfa Laval offers a wide range of automatic fuel and lubricating oil filters for reliable engine protection and lower lifecycle costs. These durable solutions have a compact design that enables flexible installation and requires a minimum of space in the engine room. Continuous backflushing prevents the adhesion of retained solids to the filter surface, which ensures long service intervals and reduced maintenance. In addition, it enables the removal of sludge by means of either a diversion chamber or a centrifuge on the backflush line, which yields superior oil conditioning efficiency.

Minimized waste for disposal

Alfa Laval full-flow filters generate far less sludge than comparable solutions. In addition, their disc-type filter elements have great advantages over cartridge-type filters. The elements' robust design prolongs the filter lifetime by eliminating the risk of cracking in the filter surface. Most importantly, however, disc-type elements eliminate the environmental disadvantages associated with filter cartridge disposal.

- Superior performance and minimized oil losses
- Robust mechanical design with rigid triple-mesh filter elements
- Continuous backflushing that prevents adhesion of solids on the filter mesh
- Market-leading sludge removal due to diversion chamber
- Low wear and tear – long maintenance intervals and no consumables
- Solutions for trunk piston and crosshead engines in the size range 500-1000 kW
- Wide range of filtration grades down to 6 µm



Alfa Laval fuel oil filter (electrically driven)



Alfa Laval lubricating oil filter

Manual filters

To complement automatic filter performance, Alfa Laval also offers a wide range of manual filters for bypass or indicator filtration. Their highly robust design ensures easy maintenance and high cleanability.

Eliminator

Suitable for lubricating oil treatment for engines burning HFO, MDO, distillate or gas fuels, the Alfa Laval Eliminator is a unique combination of two key technologies in a common housing. A full-flow automatic filter protects the engine by stopping harmful particles, while a high-efficiency disc-stack centrifuge on the backflush line efficiently cleans the lubricating oil.



Alfa Laval Eliminator

Protection and prolonged life

The Eliminator forms a sealed lube oil circuit, which protects both the oil and the environment. Contaminants cannot enter the system, nor can the oil spill or leak out. In addition, the oil lifetime is prolonged due to the continuous cleaning of the backflush flow by the high-efficiency centrifuge – which in many cases doubles the change interval. The position of the centrifuge on the backflush line, where the pollution is concentrated, ensures better cleaning than traditional installations with the centrifuge on bypass.

Pumping

ALP and 3S pumps

High-quality Alfa Laval ALP and 3S three-screw pumps are optimal for use with mineral oils, lubricants and non-abrasive oil-based liquids in marine and industrial applications. ALP three-screw pumps are characterized by a compact design with few components, which reduces pump complexity, spares consumption and handling issues. The 3S series is one of the most comprehensive three-screw pump ranges available, with 29 different pump sizes rated from 5 to 2900 l/min at 1450 rpm. Both ALP and 3S pumps have an innovative construction that ensures a long service life, even in harsh operating conditions.

- Low maintenance and minimized lifecycle cost
- High installation flexibility – a wide range of models, capacities and executions
- High volumetric and energy efficiency
- Pump screws of hardened material for tight tolerances and stable pump capacity over time
- Shaft seals of silicon carbide, with a lubricated and cooled design less vulnerable to dry running
- Efficient seal chamber construction that prevents residue around the ball bearing
- Location of the lifetime-lubricated ball bearing outside the product zone, reducing thermal risk and avoiding exposure to the pumped liquid
- Overflow valve to prevent excessive pressure
 - ALP: Fixed to prevent setting errors
 - 3S: Adjustable to differing opening pressures (3-16 bar)
- Magnetic coupling (no-wear, hermetically sealed) available to comply with SOLAS regulation for leakage-free equipment close to hot surfaces

Applications:

- Supply and circulation of fuel, from MGO to HFO
- Transfer of fuel oil
- Hydraulic oil circulation
- Lubricating oil circulation
- Lubricant and coolant pumping
- Feed and transfer pumping for oil burner technology





LNG is an attractive alternative to today's fuels, which is why its production and transport are growing rapidly. LNG carriers can take advantage of their own cargo, but this means special concerns when it comes to safety. Addressing them is a key part of Alfa Laval's portfolio of LNG solutions.

Gas combustion

Safe regulation of tank pressure

In the last decade, the propulsion of newbuild LNG carriers has shifted from steam turbine systems to dual-fuel diesel electric (DFDE) propulsion. DFDE engines, like the new generation of two-stroke dual-fuel engines, offer the owners and operators of LNG carriers an economical and environmentally sound alternative.

However, these engines require additional means of safely regulating LNG cargo tank pressure. While a number of possibilities exist, most DFDE vessels are equipped to combust the boil-off gas not used by the propulsion system.

Part of a growing LNG portfolio

The Alfa Laval Gas Combustion Unit (GCU) is a central component of boil-off management strategy. It provides a reliable, simple and compact means of safely dealing with excess boil-off gas on LNG carriers with dual-fuel or low-speed dual-fuel engines.

The GCU is joined by inert gas generators, burners, boilers, heat exchangers and more to form an extensive portfolio of Alfa Laval solutions for use with LNG. As fuel choices and cargo needs grow even more specialized, more LNG solutions and other vessel-specific equipment will follow.

Gas combustion

Gas Combustion Unit (GCU)

Specifically designed for LNG carriers, the Alfa Laval Gas Combustion Unit (GCU) is a reliable, simple and compact means of economically regulating cargo tank pressure on vessels with dual-fuel or low-speed dual-fuel engines. It safely disposes of boil-off gas when the gas cannot be used by the vessel's propulsion system, or when it is necessary to prepare the tank for inspection. The unit can also provide backup if the onboard reliquefaction plant should fail. Proven and effective, the GCU requires little maintenance and has a unique design with no perforated dome, refractory lining or expansion joints.

- Lowest possible operating costs for gas combustion technology
- Simple and compact design without any moving parts inside the combustion chamber
- Combined combustion and dilution fans that do not require silencers or duct pipes
- All-metallic combustion chamber with no refractory lining
- Electric igniters instead of an oil pilot and associated equipment
- Four operating modes available, including a partial reliquefaction mode
- Induct-type burner that offers a robust and extremely reliable design

Equipment:

- Combustion chamber
- Gas burner
- Gas valve train
- Fans and electric motors
- Control cabinet
- Power cabinets



Alfa Laval Gas Combustion Unit (GCU)

Oily waste on board comprises not only waste oil from fuel and lube processes, but also bilge water, which is usually further contaminated by chemicals and particles. Separation of the water, oil and solids is needed to protect the environment – but can also reclaim fuel losses.



Oily waste treatment

Drying up oily waste streams

The majority of oily waste is water. There is the oil-contaminated bilge water, which must be cleaned to MEPC.107(49) limits before it can be discharged into the environment. But the waste oil from separators and filters is almost 50% water as well.

Centrifugal separation is the only way to deal effectively with all of this oily waste. Using the unique Alfa Laval PureDry, every drop of liquid can be removed from the waste oil. The separated water is clean enough to be handled with the bilge water, which is cleaned with Alfa Laval PureBilge down to an oil content of less than 5 ppm.

Saving fuel and money

Water isn't the only thing PureDry can extract from waste oil. When separate tanks are used for fuel and lube oil waste, it can recover quality fuel for reuse – typically as much as 1-2% of the original volume consumed. This is as valuable as it is revolutionary.

Money is also saved by the 99% reduction in waste oil volume. With the water and oil removed, only super-dry solids are left. This allows smaller waste oil tanks to be used, which saves both space and installation cost.

Bilge water treatment

PureBilge

Alfa Laval PureBilge is an efficient and cost-effective bilge water treatment system, built for continuous use in real-life conditions. By means of high-speed centrifugal separation, it reduces oil-in-water content to less than 5 ppm – even on rough seas or in the presence of difficult emulsions. Designed to work without chemicals, PureBilge is compact and requires no large holding tanks, which means major space savings on board. It provides automatic single-stage operation and requires little maintenance, especially compared to static coalescers with filters.

- MEPC.107(49) compliance (≤ 15 ppm oil in water)
- 5 ppm DNV Clean Design Type Approval
- Continuous, fully automated operation
- Ability to handle varying feed and oil shocks
- Low waste production and lifecycle cost
- Emulsion-preventing XLrator disc inlet and optimized bowl made of high-quality material
- Compact, plug-and-play design
- Capacity: 2500-5000 l/h (5 or 15 ppm)
- Small-vessel capacity (PureBilge 0515): 500 l/h (15 ppm)

Equipment (delivered as a module):

- BWPX 307 centrifugal separator
- Ancillaries and control cabinet with Alfa Laval EPC 60 controller
- Oil-in-water monitor
- Feed pump

Immunity to pitch and roll

PureBilge cleans bilge water through of high-speed centrifugal separation, which means it is unaffected by pitch and roll. Highly reliable, the system operates continuously and produces less oily waste and reject than static solutions such as coalescer- and flocculation-type systems. Its already high separation efficiency is enhanced by its XLrator disc inlet, which gently accelerates the bilge water to prevent the creation of further emulsions.



Alfa Laval PureBilge

BlueBox data recorder

The BlueBox data recorder is a fully automatic, tamper-proof bilge data recorder with visuALog software, designed especially for Alfa Laval PureBilge. Created to prevent unacceptable bilge water discharge and to support management of the Oil Record Book, it keeps a record of oil ppm levels, GPS position, separator operation, overboard valve position and overboard flow data, as well as a full log of alarms. Tampering with the

BlueBox's cover, which encloses the OCM and sampling line, triggers an alarm and sets the overboard valve in recirculation mode.



Alfa Laval BlueBox

Waste fuel recovery

PureDry

Alfa Laval PureDry is a revolutionary high-speed separator capable of recovering reusable fuel from waste fuel oil, a process that requires separate tanks for waste fuel oil and waste lube oil. It returns as much as 1-2% of the consumed fuel volume to the fuel oil bunker tank, reducing the sludge to super-dry solids that can be landed as waste. The separated water, which has an oil content of less than 1000 ppm, is pumped into the bilge water treatment system. PureDry has an unconventional design that comprises only two main moving parts: an outer bowl shell and an insert containing the XCavator, a spiral-shaped device that ejects the dry solids without the addition of water.

- Fuel recovery and reuse in accordance with MEPC.1/Circ.642
- Payback and profit in less than one year
- Up to 2% reduction in consumed fuel volume and related costs
- Minimization of sludge – no incineration or offloading to barges
- No oil losses or additional generated wastes
- Discharge without sensitive hydraulics or displacement water
- Records of all flows kept by Alfa Laval EPC 60 controller – no gaps in Oil Record Book
- Easy operation, with simple Maintenance and Service by Exchange (MSE)



Alfa Laval PureDry

Integrated handling of oily waste

PureDry is the first product to take advantage of MARPOL rule MEPC.1/Circ.642, which allows the reuse of the HFO fraction of waste fuel oil as fuel for the diesel engines. This creates a direct savings in fuel costs, while the massive reduction in water content means less waste to store and deposit. Together, PureDry and PureBilge form an integrated waste oil and bilge water handling system that deals with all oily waste streams.

Dry up your waste oil worries

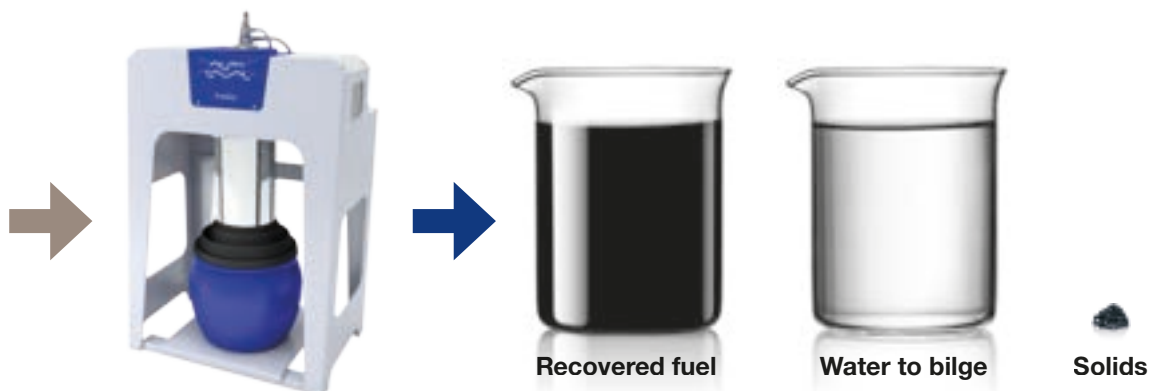



Steam and heat have a fundamental role in many onboard processes. Whether by using oil and gas or by economizing the energy already in motion on board, Alfa Laval finds increasingly efficient ways to generate steam and heat – and to distribute them where they're needed most.



Steam and heat generation

A century of skill in heat supply

Alfa Laval Aalborg steam and heat generation solutions represent a unique body of knowledge. They stand for nearly 100 years of innovation, from energy-efficient pin-tube elements to composite boilers and low-pressure thermal fluid systems.

Even more importantly, they stand for thermal expertise. Because we understand the consumers as well as the producers of steam and heat, we can fine-tune the production for the greatest energy efficiency downstream.

Creating optimized thermal systems

Advances are still being made. Among the greatest are those that come from linking technologies together.

Today we're exploring not only new boiler constructions, but also new ways of combining equipment for even greater effect. Our Energy Management System for thermal fluid, for example, reduces fuel use by prioritizing heat distribution according to the needs of connected consumers.

Steam and hot water production

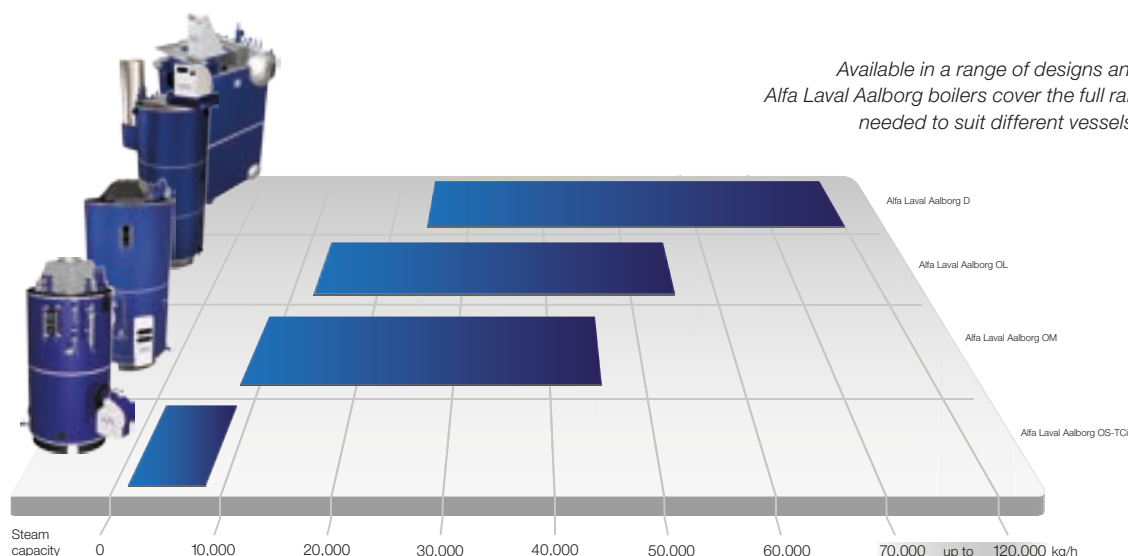

Intuitive control as standard

Today all Alfa Laval Aalborg boilers are delivered with Alfa Laval Touch Control, a robust and future-proof control solution based on a programmable logic controller (PLC). Alfa Laval Touch Control offers a complete plant overview,

with intuitive access to any function or setting in two touches of the screen. For existing boiler systems, it is also available as a retrofit (see page 94).

Composite boilers (oil-fired + exhaust gas)

Aalborg OC-TCi

Intended for steam production, the high-performance Aalborg OC-TCi is a space-saving combination boiler fired with both oil and exhaust gas. Preassembled and installed vertically, it consists of an oil-fired module with helix tubes and an exhaust-gas-fired module with smoke tubes. In the Aalborg OC-TCi Multiple Inlet version, the latter module is suitable for use with one main engine and two auxiliary engines. The boiler provides effective self-cleaning, thanks to its built-in TCi (Turbo Clean, intelligent) technology and its relatively high gas velocity compared to other composite boilers. It can also be fitted with a compact silencer to suit any type of diesel engine.

- Combined oil- and exhaust-gas-fired production of steam
- TCi (Turbo Clean, intelligent) technology for improved efficiency and self-cleaning without water washing
- Inlets for three exhaust gas sources (Aalborg OC-TCi Multiple Inlet)
- Design pressure: 10 bar(g)
- Capacity:
 - 750-8000 kg/h (oil-fired section)
 - 180-5000 kg/h (exhaust-gas-fired section)

Burner recommendation:

- Aalborg KBM pressure-atomizing burner



Alfa Laval Aalborg OC-TCi

Small- and medium-capacity boilers (oil-fired)

Aalborg OS-TCi

Intended for steam production, the Aalborg OS-TCi is supplied as a vertical, preassembled boiler unit. This reliable, high-efficiency boiler is constructed with helix tubes and features a user-friendly, integrated pressure-atomizing burner. The boiler's built-in TCi (Turbo Clean, intelligent) technology makes it self-cleaning to the highest possible degree, and what little maintenance remains is easy and has a low environmental impact.

- Oil-fired production of steam
- TCi (Turbo Clean, intelligent) technology for improved efficiency and self-cleaning without water washing

- Design pressure: 10 bar(g)
- Capacity: 750-8000 kg/h

Burner recommendation:

- Aalborg KBM pressure-atomizing burner



Alfa Laval Aalborg OS-TCi

Aalborg OM

The Aalborg OM is supplied as a vertical, preassembled boiler unit. Two design pressures are available, as well as two different models: OM and OM-TCi. The OM model produces steam or hot water and has optimally designed pin-tube elements, which also support the top plates of the furnace and boiler. The OM-TCi model, for steam only, is designed with smoke tubes and features self-cleaning TCi (Turbo Clean, intelligent) technology. In both models, the furnace consists of membrane walls with a number of large tubes in between, and sufficient circulation is ensured by downcomers placed within the tubes.

- Oil-fired production of steam or hot water (OM)
- Oil-fired production of steam (OM-TCi)

- Design pressure: 11 or 18 bar(g)
- Capacity:
 - 8000-45,000 kg/h (OM)
 - 8000-20,000 kg/h (OM-TCi)

Burner recommendation:

- Aalborg KBE rotary cup burner
- Aalborg KBSA pressure-atomizing burner



Alfa Laval Aalborg OM

Optimized efficiency downstream

All Alfa Laval Aalborg boiler models have a basic design that supports the highest possible energy efficiency. However, each boiler is individually constructed to match the specifications of the heat consumers it will serve.

By analyzing needs downstream, Alfa Laval can adapt the output temperature and pressure to ensure the highest energy efficiency in the steam line as a whole.

Large-capacity boilers (oil-fired)

Aalborg OL

Intended for steam or hot water production, the Aalborg OL is supplied as a vertical, two-drum cylindrical boiler. Its furnace, which is built with membrane walls and contains only little refractory material, is shaped to provide optimal combustion conditions. The convection section consists of straight pin tubes with bent pins, which provide a high coefficient of heat transfer and a low pressure loss, and circulation is ensured by downcomers placed outside the membrane walls. Two design pressures are available.

- Oil-fired production of steam or hot water
- Design pressure: 9 or 18 bar(g)
- Capacity: 12,500-55,000 kg/h

Burner recommendation:

- Aalborg KBSD steam-atomizing burner



Alfa Laval Aalborg OL

Aalborg D

Intended for steam or hot water production, the Aalborg D is supplied as a vertical, two-drum boiler with a D-type design. Its furnace is built with membrane walls and contains only little refractory material. The convection section consists either of bare tubes or of straight pin tubes with bent pins, which provide a high coefficient of heat transfer and a low pressure loss. Circulation is ensured by downcomers placed outside the membrane walls.

- Oil-fired production of steam or hot water
- Design pressure: 18 bar(g)
- Capacity: 25,000-120,000 kg/h

Burner recommendation:

- Aalborg KBSD steam-atomizing burner



Alfa Laval Aalborg D

Composite boilers (dual-fuel + exhaust gas)

Aalborg OC

Intended for steam production, the high-performance Aalborg OC is a space-saving combination boiler fired with exhaust gas in addition to oil and gas fuels. Preassembled and installed vertically, it consists of an oil-fired module with pin tubes and an exhaust-gas-fired module with smoke tubes. The pin-tube elements are integrated so as to support the furnace and the boiler top plate, which achieves both lower weight and improved strength. The boiler can be fitted with a compact silencer to suit any type of diesel engine.

- Combined oil-, gas- and exhaust-gas-fired production of steam

- Inlets for three exhaust gas sources
- Design pressure: 9 bar(g)
- Capacity:
 - 750-6500 kg/h (oil- and gas-fired section)
 - 300-5000 kg/h (exhaust-gas-fired section)

Burner recommendation:

- Aalborg KBOG-E dual-fuel pressure-atomizing burner



Alfa Laval Aalborg OC

Small- and medium-capacity boilers (dual-fuel)

Aalborg OS

Intended for steam production, the Aalborg OS is supplied as a vertical, preassembled boiler unit. Its high performance is ensured by the use of optimally designed pin-tube elements, which are also used to support the top plates of the furnace and boiler. Inclined mounting of the burner enables good combustion with all fuel grades.

- Oil- and gas-fired production of steam
- Design pressure: 10 bar(g)
- Capacity: 1600-6500 kg/h

Burner recommendation:

- Aalborg KBOG-E dual-fuel pressure-atomizing burner



Alfa Laval Aalborg OS

Large-capacity boilers (dual-fuel)

Aalborg OL

Intended for steam or hot water production, the Aalborg OL (described in full on page 64) can be supplied as a dual-fuel solution fired by either liquid or gas fuel. Only the burner configuration differs from the oil-fired version.

- Oil- and gas-fired production of steam or hot water
- Design pressure: 9 or 18 bar(g)
- Capacity: 10,000-55,000 kg/h

Burner recommendation:

- Aalborg MPF dual-fuel steam-atomizing burner

Aalborg D

Intended for steam or hot water production, the Aalborg D (described in full on page 64) can be supplied as a dual-fuel solution fired by either liquid or gas fuel. Only the burner configuration differs from the oil-fired version.

- Oil- and gas-fired production of steam or hot water
- Design pressure: 18 bar(g)
- Capacity: 25,000-120,000 kg/h

Burner recommendation:

- Aalborg MPF dual-fuel steam-atomizing burner

Thermal fluid heating systems

Aalborg TFO (oil/gas-fired)

The Alfa Laval Aalborg TFO is an oil- or gas-fired heater for thermal fluid, delivered as part of a complete thermal fluid heating system that includes all necessary components. Available in both vertical and horizontal executions, it has a heavy insulation jacket and is constructed with a double coil of bare tubes, which can be accessed for inspection and cleaning by means of a removable top plate. The Aalborg TFO has a three-pass flue gas configuration that results in high efficiency, as well as a low thermal fluid pressure drop.

- Mineral oils or hot water possible as a heat transfer medium
- Thermal fluid design temperature: 280°C
- Capacity: 100-20,000 kW

Complete system delivery includes:

- Oil-fired heaters
- Burners
- Economizers
- Control panels
- Circulation pumps
- Valves
- Expansion tanks
- Dump coolers
- Tank cleaning heaters
- Heat exchangers
- Electric heaters (50-3000 kW)
- Unfired steam boilers
- Spare parts



Alfa Laval Aalborg TFO

Aalborg EX (waste heat recovery)

The Alfa Laval Aalborg EX is an exhaust gas economizer for heating thermal fluid, delivered as part of a complete thermal fluid heating system that includes all necessary components. Installed vertically and tailored specifically to each application, it secures optimal heat recovery from the engine exhaust gases. Designed with low pressure loss and constructed with coils of bare tubes, it has integrated soot-cleaning nozzles at the exhaust gas inlet and a top-mounted nozzle system for firefighting. If desired, it can also be equipped with integrated inlet and outlet boxes and with integrated exhaust gas bypass dampers.

- Thermal fluid design temperature: 300°C
- Capacity: 100-5000 kW

Complete system delivery includes:

- Oil-fired heaters
- Burners
- Economizers
- Control panels
- Circulation pumps
- Valves
- Expansion tanks
- Dump coolers
- Tank cleaning heaters
- Heat exchangers
- Electric heaters (50-3000 kW)
- Unfired steam boilers
- Spare parts



Alfa Laval Aalborg EX

Energy recovery and adaptive distribution

A complete thermal fluid heating system from Alfa Laval offers two ways to reduce fuel consumption and emissions. The Aalborg EX exhaust gas economizer recovers waste heat that would otherwise escape with the exhaust gas, using it to warm the thermal fluid. Once in circulation, the heat energy can be efficiently distributed by the Alfa Laval Aalborg Energy Management System (see next page), which adapts the heat flow to the actual needs of the heat consumers. This means the oil-fired boiler can be used less often.

Thermal fluid system control

Aalborg Energy Management System (EMS)

The Alfa Laval Aalborg Energy Management System (EMS) is a control and monitoring system for the ship's heat consumers. It avoids unnecessary fuel oil consumption and emissions by comparing the available heat with the actual requirements of the heat consumers, all of which are incorporated into the system. This effectively minimizes peak loads and limits supplemental firing of the oil-fired heater. The heat consumers are managed via a touchscreen, from which the desired temperature and warmup time can be set. If sufficient heat is not available, for example when the vessel is in port, selected consumers are temporarily shut down automatically according to a preferential sequence.



Alfa Laval Aalborg Energy Management System (EMS)



Your livelihood depends on the contents of your tank. Preventing contamination is vital, as is ensuring a short turnaround time in port. Alfa Laval can make easy work of achieving a clean tank environment, with high-performance cleaning technologies in a thoroughly optimized installation.



Tank cleaning

Dynamic cleaning technologies

Automated and efficient, Alfa Laval Gunclean Toftejorg tank cleaning solutions represent over 50 years of optimization. With a helical or criss-cross spray pattern that reaches the whole tank in a fraction of the traditional cleaning time, they eliminate both hassle and expense.

Our single- and dual-nozzle technologies have evolved to include the hysteresis clutch of our Alfa Laval i40 and i65 series, which prevents false starts and eliminates the leakage risk of a second shaft penetration.

Optimized installation design

Supporting our nozzle technologies is our unique Alfa Laval G-Pass design software. G-Pass goes beyond shadow diagrams to produce a 3D simulation of your tank – showing its corrugations, stringer platforms and other internal obstructions from all angles.

Using G-Pass for a total assessment, we evaluate the position, quantity, jet length and jet hit angle of the tank cleaning machines. This ensures an optimized installation that prevents product build-up and reduces fluid and energy use.

Tank cleaning technology

The i40 and i65 tank cleaning platforms

The Alfa Laval Gunclean Toffejorg i40 and i65 tank cleaning platforms are the latest technology developments and represent today's most advanced tank cleaning solutions. Available in single-, dual- and multi-nozzle machines, they combine a wear-resistant design with a range of unique mechanical advances. Chief among these is the patented hysteresis clutch (see right), which provides built-in speed adjustment and prevents slippage during water hammering or sudden pressure surges. Other improvements include an optimized turbine and friction-reducing ceramic balls that enhance lifetime performance.

- Topside speed adjustment during operation
- No speed adjustment shaft – reduced risk of seal leakage
- Zero slippage for an uninterrupted cleaning cycle
- Optimized turbine for maximum power transmission
- Durable design and low-wear materials for reduced spare parts consumption



Hysteresis clutch and turbine

Fluid-reducing coverage

For vessels with cargoes that do not necessitate hard-impact cleaning, dual-nozzle machines are the right choice. Since the fluid is distributed by two nozzles, the tank surfaces are covered twice as fast. This results in lower fluid consumption and less slop.

Jet length

Alfa Laval's optimized nozzle design ensures the longest jet length on the market. This has been shown in official tests of throw length by DNV, in which Alfa Laval nozzles reach up to 35% farther than the second-best alternative. This difference is due to competitor machines dropping more water on the way from the nozzle to the tank wall. With a more effective nozzle design, a smaller nozzle can reach the same distance with the same efficiency as a larger nozzle.

Less energy and slop

The use of smaller nozzles for the same task means less water consumption, which translates into steam and fuel savings when cleaning with hot water. When cleaning for several hours on a vessel with tanks 20 m in length, the savings per tank can be more than USD 160 per hour, plus savings related to pumping. In addition, there will be less slop water for delivery to onshore facilities.

Tank cleaning machines

Small deck-mounted machines

The machines in the Alfa Laval Gunclean Toftejorg i40 and i65 series are second-generation, high-impact tank cleaning machines. Developed to meet the toughest tank cleaning requirements, they feature a hysteresis clutch with built-in speed adjustment.

- For chemical tankers, product tankers and offshore
- Single-nozzle, dual-nozzle and multi-level versions
- Stainless steel where in contact with cargo
- No slippage, no shaft seal to leak
- Working pressure: 5-12 bar(g)
- Capacity: 5-45 m³/h



Large deck-mounted machines

The Alfa Laval Gunclean Toftejorg i270 is the next generation of our well-proven 270 FT Mark I machine. Fully programmable and turbine-driven, the Gunclean Toftejorg i270 is the most-sold single-nozzle tank cleaning machine for crude oil tankers and bulk carriers. Its four programs range from quick cleaning to high-pitch, heavy-duty cleaning.

- For crude oil tankers, bulk carriers and FPSOs
- Inlet house in galvanized or epoxy-coated steel
- Downpipe in galvanized or stainless steel
- Cleaner head now only available in stainless steel
- Working pressure: 7-12 bar(g)
- Capacity: 30-110 m³/h



Dual-nozzle machines with internal drive

Alfa Laval Gunclean Toftejorg dual-nozzle machines are typically submerged aboard crude oil tankers or used as portable equipment. They are also ideal for the small tanks of supply vessels, where their criss-cross spray pattern distributes cleaning media faster and more evenly than manual cleaning.

- For use on all types of tankers
- Fixed and portable versions
- Stainless steel where in contact with cargo
- Many different thread connections and inlet flanges
- Working pressure: 5-12 bar(g)
- Capacity: 7-90 m³/h



Cleaning optimization software

G-Pass

Alfa Laval G-Pass software is a unique approach to optimizing tank cleaning solutions. It creates a three-dimensional image of your tank and its internal obstructions, which can be rotated to any angle to show the “shadows” that are not directly hit by the tank cleaning jets. G-Pass bases its calculations on the tank’s actual construction and can make use of details that are normally disregarded, including faceplates, PMAs, ladders and pump stacks. Its true-to-life results, based on the position, quantity, jet length and jet hit angle of the proposed cleaning machines, can be documented as shadow diagrams in accordance with IMO standards and individual or special requirements.

- Presentation of cleaning results as an easily interpreted 3D representation
- Inclusion of internal obstructions, e.g. corrugations and stringer platforms
- Elimination of human error in shadow diagram preparation
- Fully optimized results when used with appropriate definitions of jet length and jet hit angle (DNV and NK definitions recommended)

Cleaning with fewer resources

Using 3D to achieve optimal positioning of the tank cleaning machines reduces the need for additional cleaning with portable machines. As a result, there is a reduction in cleaning fluid, fluid heating and slop disposal.

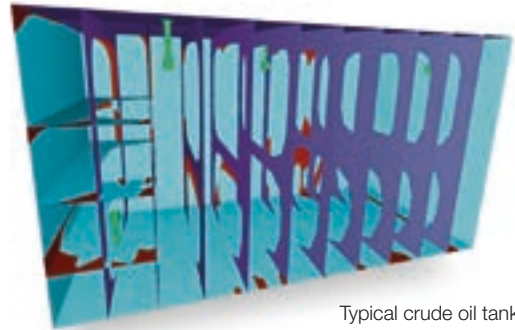

Typical crude oil tank

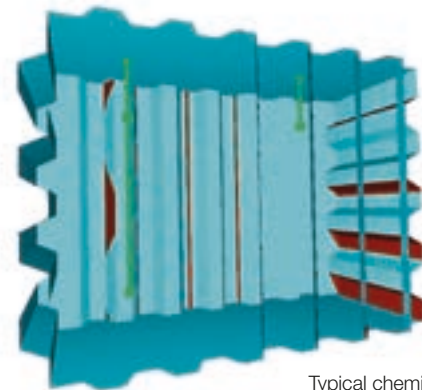

Typical chemical tank

Alfa Laval G-Pass creates a three-dimensional view of your tank that can be rotated in any direction. All obstructions are present and areas not directly hit by the cleaning jets are clearly shown.

The transport of cargo by sea is crucial, but at times the cargo itself is a potential danger. Keeping volatile cargo under control is always a primary concern. Drawing on a long history of work with tankers, Alfa Laval has the knowledge and tools to ensure a stable and safe tank environment.



Tanker safety

Inert gas for volatile cargo

Alfa Laval has spent decades optimizing cargo safety under the Smit name. Today we're the market leader in the supply of inert gas systems for maritime applications. These systems degrade the oxygen level in the cargo tank, thus preventing a combustible atmosphere.

We produce inert gas through a number of methods, adapted to the safety requirements posed by IMO and the classification societies. The majority of our inert gas systems are based on the unique Ultramizing® principle, which atomizes the fuel oil for soot-free inert gas, even at partial loads.

Developed to make a difference

Our inert gas production systems are increasingly modular, which streamlines both installation and the systems themselves. Greater modularity means tailored systems that are a perfect fit for both vessel and budget.

Unchanged is the assurance of having Alfa Laval close at hand, for everything from fast quotation turnaround to local spare parts availability. For systems so important to safety and the ability to arrive on schedule, our worldwide network means peace of mind.

Inert gas production

Smit LNG/LPG

The Alfa Laval Smit LNG/LPG system is a combustion-type inert gas generator, producing low-pressure and low-dew-point inert gas. It is the most complex of the inert gas systems, found on LNG and LPG carriers. For these carriers a very dry and high-quality inert gas is required, also referred to as inert gas with a low-dew point. The Smit LNG/LPG system has integrated controls and consists of four main components.

Technical data:

- Capacity: 1500-25,000 m³/h
- Design: Combustion + drying
- Pressure: 0.25, 0.3 or 0.4 bar(g)
- Typical oxygen content: 0.5-1%
- Fuel type: DMA, DMB, DMZ
- Fuel atomizing: Air/steam
- Dew point: Dry -45/-65°C

Main components

■ Generator

The generator is horizontal and allows easy inspection and maintenance, although maintenance is seldom required.

■ Cooler

The cooler, which has an inert gas contact surface of SUS 316 for lifetime service, takes up minimal space due to the low-temperature output of the generator.

■ Chiller

By using water from the chiller as an intermediate heat transfer medium between chiller and cooler, stable heat transfer is provided under all load conditions.

■ Dryer unit

The dryer unit is redundant and provides additional security.

Applications:

- LNG carriers
- LPG carriers
- FPS



Alfa Laval Smit LNG/LPG

Smit Combustion

The Alfa Laval Smit Combustion system is a low-pressure, combustion-based system for inert gas production. At the system's heart, fuel oil and air are combusted by the unique Smit Ultramizing system. This produces soot-free inert gas with an oxygen content of 2-4%, even when below stoichiometric conditions. The Smit Combustion system can be equipped with an optional Alfa Laval Automatic Fuel Efficiency Module (AFEM) for fuel saving purposes.

Technical data:

- Capacity: 1000-20,000 m³/h
- Design: Combustion
- Pressure: 0.15 bar(g)
- Typical oxygen content: 2-4%
- Fuel type: DMA, DMB, DMZ
- Fuel atomizing: Air
- Dew point: Saturated

Applications:

- Product tankers
- Chemical tankers
- FPS



Alfa Laval Smit Combustion

Smit Flue Gas

The Alfa Laval Smit Flue Gas system is a scrubber-based inert gas system, specifically designed to utilize the flue gas from oil-fired boilers. It is primarily used on crude oil tankers. The current system offers a unique combination of improved particle removal and a compact layout. It was developed on the basis of customer feedback to provide simplicity of installation and a range of operational advantages.

Topping up en route

As an addition to the Alfa Laval Smit Flue Gas system, an optional topping-up system can be included. As the name indicates, the topping-up system is meant to produce small amounts of inert gas to top up the cargo tank and keep it pressurized during the voyage. The topping-up system is basically a small (500 m³/h) Alfa Laval Smit Combustion system, combusting fuel oil and air to produce inert gas. This allows the operator to top up the cargo tank with inert gas even when the boilers are not in operation.

Technical data:

- Capacity: 3000-30,000 m³/h
- Design: Flue gas cleaning
- Pressure: 0.1 bar(g)
- Fuel type: Flue gas from HFO-fired boiler
- Dew point: Saturated

Applications:

- Crude oil tanker
- Product tankers
- FPS



Alfa Laval Smit Flue Gas

Smit Combined

The Alfa Laval Smit Combined system is a combination of the Alfa Laval Smit Combustion and Alfa Laval Smit Flue Gas systems. This means the system can operate in two modes, either as a standalone combustion-type system or as a flue gas system utilizing exhaust gas from a boiler. Whenever clean inert gas is required, the combustion mode can be activated to combust fuel oil and air. In the case of crude oil transport, boiler flue gas can be utilized to produce inert gas without any fuel oil. This unique combination saves fuel oil, which benefits the owner and the environment without compromising safety or reliability.

Technical data:

- Capacity: 1000-20,000 m³/h
- Design: Combustion + flue gas cleaning
- Pressure: 0.13 bar(g)
- Typical oxygen content: 2-4%

- Fuel type: DMA, DMB, DMZ, flue gas from HFO-fired boiler
- Fuel atomizing: Air
- Dew point: Saturated

Applications:

- Product tankers
- Crude carries
- FPS



Alfa Laval Smit Combined

Smit Combustion Portable

The Alfa Laval Smit Combustion Portable system is a compact and portable version of the Alfa Laval Smit Combustion system. This easily moved system is typically applied as a temporary solution while the main inert gas generator is out of order, or on salvage jobs. The Alfa Laval Smit Combustion Portable system can be airlifted without modification or disassembly and has a fixed capacity of 2000 m³/h.

Technical data:

- Capacity: 2000 m³/h
- Design: Combustion
- Pressure: 0.15 bar(g)
- Typical oxygen content: 2-4%
- Fuel type: DMA, DMB, DMZ
- Fuel atomizing: Air
- Dew point: Saturated

Applications:

- Temporary usage or salvage jobs on:
- Crude carriers
- Product tankers
- Chemical tankers
- FPS



Alfa Laval Smit Combustion Portable



Today's modern engine systems are considerably more efficient than their predecessors. Yet much of the energy they produce still goes to heat rather than propulsion. By recapturing this energy and putting it to use, Alfa Laval reduces both fuel consumption and emissions.



Waste heat recovery

From waste heat to added value

The recovery of waste heat is a unique opportunity that benefits your bottom line as much as the environment. This is why – with 50% of a main engine's fuel energy going to heat loss – using exhaust gas to generate steam is so attractive.

Alfa Laval Aalborg waste heat recovery systems deliver documented fuel savings and CO₂ reductions of up to 14%. Our extensive experience lets us design and install systems that maximize energy gains without any compromise in onboard safety.

Multiple sources and ways to save

Today it pays to look at all energy sources. Recovering heat energy from auxiliary engine exhaust, for example, can do more than meet steam needs in port. For vessels whose long-stroke main engines produce cooler exhaust, it can provide a needed boost in steam production en route.

Moreover, waste heat recovery is a broader application than ever before. Not limited to serving onboard equipment, today's waste heat recovery systems can be constructed to support propulsion by means of an electric motor integrated into the shaft line.

Main heat recovery

Aalborg XW-TG

An enhanced version of the Alfa Laval Aalborg XW, the Alfa Laval Aalborg XW-TG has been modified to more efficiently utilize the waste energy from large diesel engines, with reduced fuel consumption and CO₂ emissions as a result. Like the standard version, it is constructed with double-gilled water tubes and operates with forced circulation. However, the Aalborg XW-TG provides superheated steam for power generation by means of a steam-turbine-driven (turbo) generator. Because the heat recovery rates involved demand larger heating surfaces, it also features safety enhancements such as bypass dampers and extended monitoring equipment.

- Design pressure: 6-24 bar(g)
- Capacity according to ship's specification

Options:

- Single- or dual-pressure configurations
- Single-gilled or bare tubes (double-gilled as standard)
- Dividing wall system for connecting several exhaust gas sources



Alfa Laval Aalborg XW-TG

Reliable energy returns

Waste heat recovery increases main diesel engine efficiency by reclaiming around half of the energy otherwise lost in the exhaust. Maximizing the energy returns requires high operational reliability, however, which the Aalborg XW-TG ensures by a number of means. The gills of the economizer's heating surface, for example, are spaced in a way that minimizes soot-build up. In addition, they are cleaned on-load by a highly efficient, electrically operated sootblowing system using steam or compressed air.

Aalborg XW

Constructed with water tubes and operating with forced circulation, the Alfa Laval Aalborg XW is intended as an exhaust gas economizer for main diesel engines. Its robust design, however, is suited to numerous applications. The heating surface is made up of double-gilled tubes as standard, with a spacing that minimizes soot build-up. In addition, there is an efficient cleaning system that uses steam or compressed-air sootblowers. The economizer can be used in conjunction with an oil-fired auxiliary boiler or a separate steam drum, in both cases acting as a steam/water separator.

- Design pressure: 18 or 24 bar(g)
- Capacity according to ship's specification

Options:

- Single-gilled or bare tubes (double-gilled as standard)
- Dividing wall system for connecting several exhaust gas sources
- Integrated silencer



Alfa Laval Aalborg XW

Aalborg XS-2V and XS-7V

Constructed with smoke tubes, the Alfa Laval Aalborg XS is an exhaust gas economizer for main diesel engines. It is available in two models, both of which have a vertical design and a high gas velocity that minimizes fouling. The Aalborg XS-2V has its own steam space and can operate independently from the oil-fired boiler / steam drum. The Aalborg XS-7V has no steam space and is designed for forced circulation and operation with an oil-fired boiler.

- Design pressure: 10 bar(g)
- Capacity according to ship's specification

Options:

- With (XS-2V) or without (XS-7V) own steam space
- Integrated silencer



Alfa Laval Aalborg XS-7V



Alfa Laval Aalborg XS-2V

Auxiliary heat recovery

Aalborg XS-TC7A

Constructed with smoke tubes, the Alfa Laval Aalborg XS-TC7A is a compact and efficient exhaust gas economizer for installation after the auxiliary engines. When used in combination with a waste heat recovery system installed after the main engine, it significantly reduces the oil consumption of the oil-fired boiler under most load conditions. Since the operation of the auxiliary engines is not continuous, the economizer has been developed for varying loads. It features a specialized convection section, optimized to augment heat transfer through increased turbulence at the exhaust gas boundary layer. This allows increased steam production while reducing the economizer's weight in comparison to other waste heat recovery systems.

- Design pressure: 10 bar(g)
- Capacity according to ship's specification
- Ability to support steam demand during port stays
- Potential positive influence on Energy Efficiency Design Index (EEDI)

Options:

- With or without own steam space

Aalborg XW Superheater

The Alfa Laval Aalborg XW Superheater is a superheater system for auxiliary boilers. Built in the same manner as the Aalborg XW exhaust gas economizer, with water tubes and forced circulation, it provides fuel savings in the operation of steam-turbine-driven cargo pumps on tankers. This is because running with superheated steam both reduces the outlet temperature of the flue gas from the boilers and increases the thermal efficiency of the turbine. No change in the auxiliary boiler heating surface is necessary. Likewise, no flue gas bypass is required, since the superheater design allows dry running when only saturated steam is needed.

- Design pressure: 18 or 24 bar(g)
- Capacity according to ship's specification

- Resistance to dry running (within certain parameters) for continuous operation even when performing maintenance



Alfa Laval Aalborg XS-TC7A

Untapped energy potential

Exhaust gas from the auxiliary engines has been an overlooked energy source. But because the cooler exhaust of long-stroke main diesel engines can be insufficient to support steam needs, it is becoming more attractive. Auxiliary engine exhaust gas can fulfil steam requirements during port stays or even en route, giving the Aalborg XS-TC7A a short payback time.



Alfa Laval Aalborg XW Superheater

Rapid payback in fuel savings

The Aalborg XW Superheater improves the environmental profile of a vessel by greatly increasing the efficiency of the cargo pump turbine. The fuel savings resulting from its installation can be as high as 10-15%, which can mean a rapid return on investment.

Needs and conditions frequently change. But the reasons for choosing Alfa Laval remain valid throughout your equipment's lifetime. Alfa Laval Service is available wherever you sail, with skilled experts who can optimize your equipment and ensure the uptime you count on.



Service

Extending performance

Alfa Laval Service keeps you confident in your Alfa Laval equipment – throughout its lifetime. At sea and in key harbours worldwide, as well as by phone and online, our committed team provides knowledge, solutions and services to secure and extend performance.

Our experts listen closely to how you use your equipment. Whatever its type or age, they know ways to safeguard and enhance its operation. Drawing on experience from similar situations around the world, they can recommend the right solutions for you.

A complete service offering

Our 360° Service Portfolio contains services and solutions for every aspect of your equipment and its life cycle. Among them are solutions that help you adapt to changing drivers and regulations, including ways for existing equipment to benefit from new R&D.

Our services and expertise ensure the best return on your investment, even as your operations develop and change over time. You choose the options that are right for you, and you can combine any of them in a Performance Agreement to match your specific needs.

Extending performance

Alfa Laval has an extensive global network dedicated to helping you get the most from your equipment. The experts of Alfa Laval Service, available 24/7 and wherever you sail, are ready to help you experience maximum uptime and the highest degree of optimization.

- *Alfa Laval field service network*
- *Framo service centres*

across the world

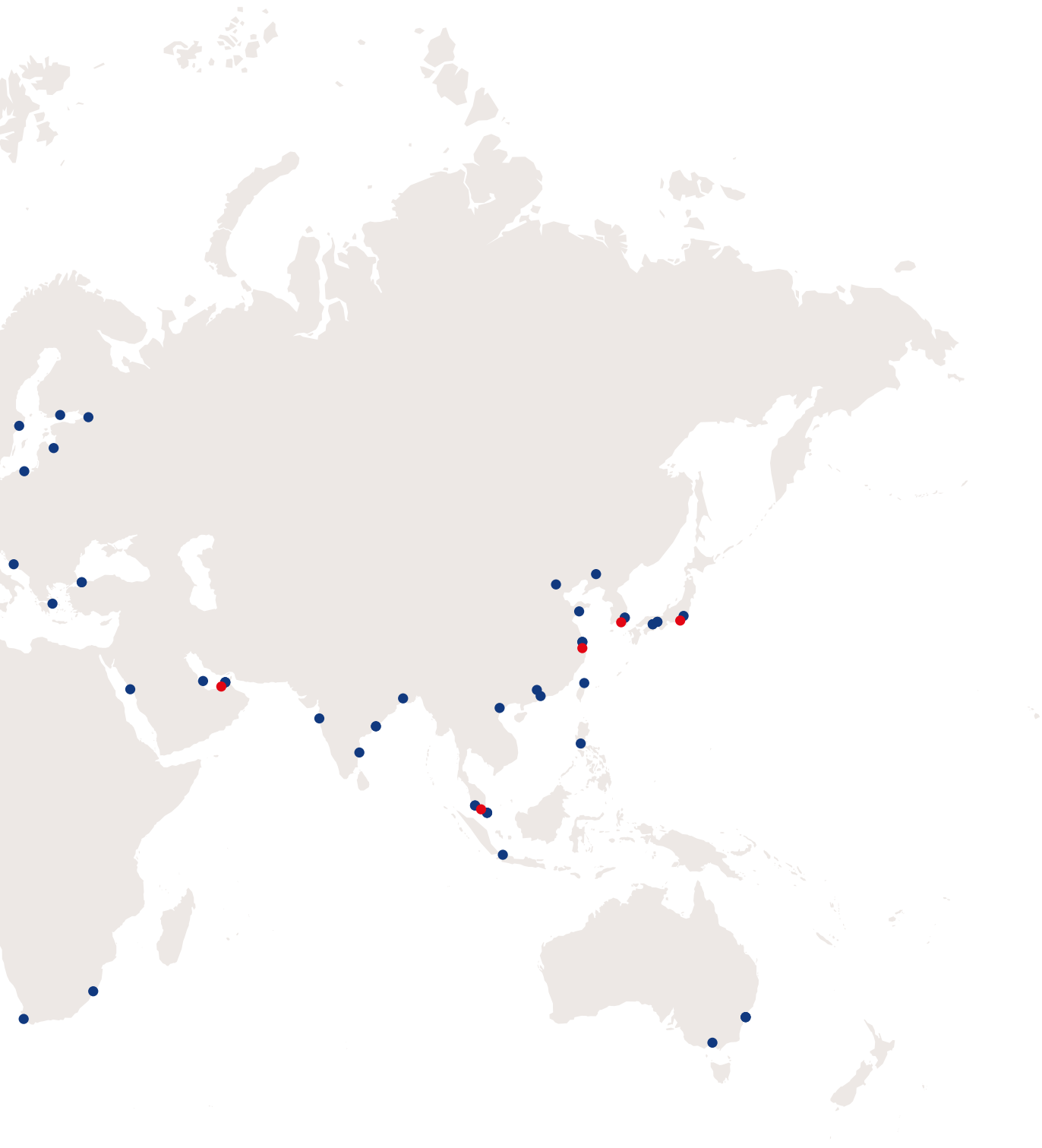

The Alfa Laval field service network reflects the breadth of our product portfolio. Some services, e.g. boiler and inert gas generator repair, are only available at selected service centres.

Extending performance in 360°

As slow steaming, new fuels and other factors change the way you operate, Alfa Laval is a constant that can keep you going strong.

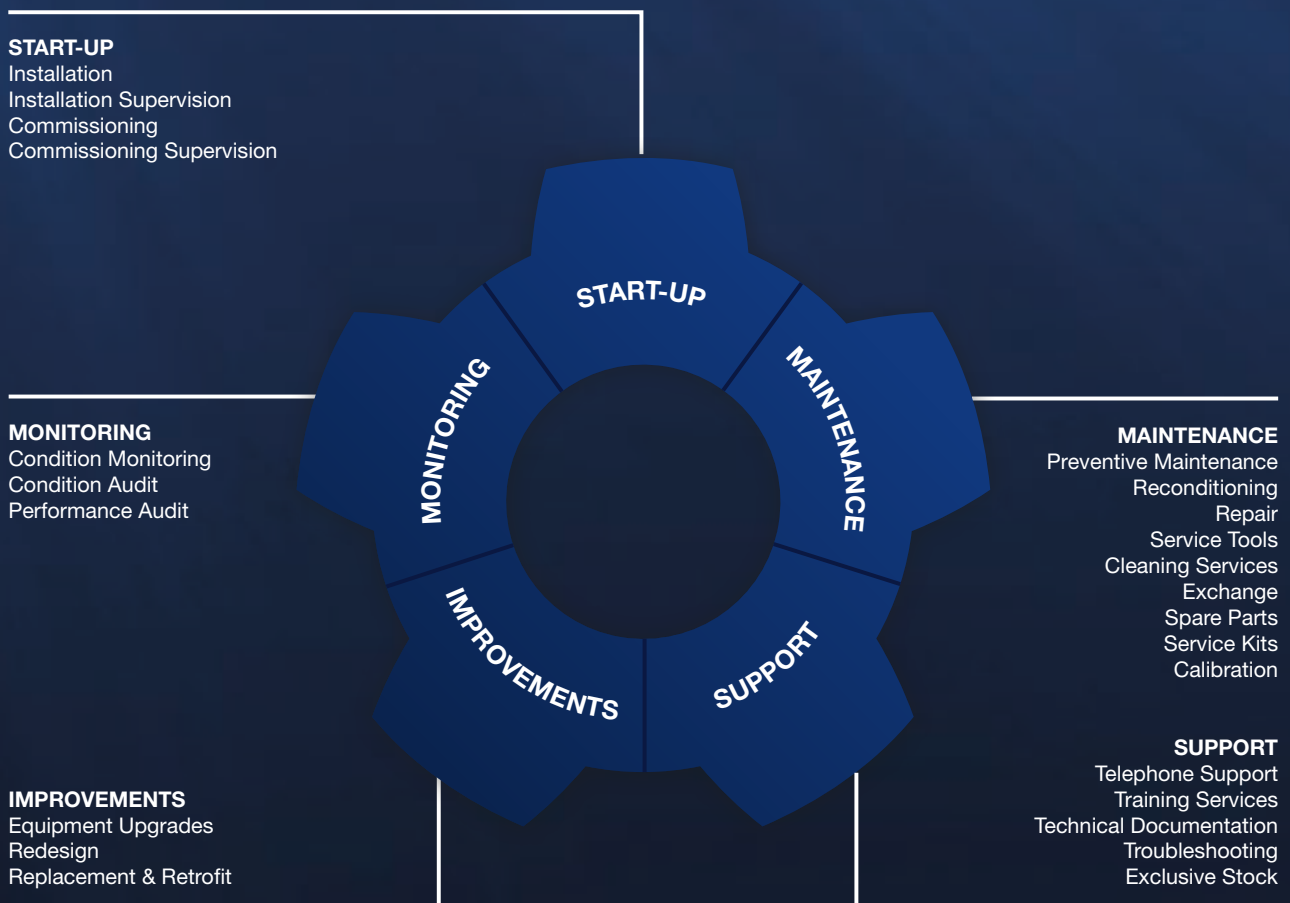

Performance Agreements

Alfa Laval Performance Agreements are tailor-made service solutions that combine true peace of mind with advance knowledge of your service costs and a short payback time. They meet your specific needs by combining any of the services in our 360° Service Portfolio over a defined period of time.

With a Performance Agreement, you achieve a total result that is greater than that of the individual services. You get top performance, maximum uptime and system optimization throughout your equipment's life cycle.

Some of the benefits compared to buying single services are:

- Predictability and peace of mind
- Fixed yearly costs
- Access to special services only available in an agreement
- Top-level efficiency throughout the entire equipment lifecycle



As tailor-made solutions, Alfa Laval Performance Agreements can take many forms. The following example gives an idea of what might be included.

Performance Agreement for Alfa Laval PureBallast

Under a Performance Agreement for Alfa Laval PureBallast, we establish and sustain a cooperative business relationship with you. This provides measurable benefits, achieved through continuous improvement and collaboration. Together we safeguard a self-sufficient and compliant vessel, whose crew is able to operate and service the equipment according to Alfa Laval recommendations for achieving maximum performance and reliability.

The Performance Agreement includes:

- **Consumables and parts** for scheduled maintenance, such as Cleaning-in-Place (CIP) fluid and seal kits
- **Emergency spare parts** to ensure the system can be repaired and used without incurring delays or penalties

Alfa Laval PureBallast 3.1



- **Round-the-clock technical support** by phone from our Graduated Service Engineers (GSEs) and PureBallast system specialists
- **Annual onboard visits** from a PureBallast system specialist, including evaluation with a written report, any software upgrades, suggestions for improvements and sharing of best practices
- **Onboard training** of the crew that operates and services the PureBallast system

The onboard visits and trainings included in the scope of services are available in four strategically chosen major port areas around the globe.

Start-up services

The beginning of a healthy life cycle

Avoiding errors at the outset can save headaches and money over time. We help you get every detail of your start-up right with a full range of services – from strategic consultation to hands-on installation.

Our skilled engineers are at your service every step of the way. They use their knowledge to ensure your equipment is ready for coming challenges, and to put it into operation as smoothly and safely as possible. With Alfa Laval on your side during start-up, you can be sure every piece of equipment will live up to expectations and perform like it should over the long haul.



Installation

Optimal lifetime performance demands getting off on the right foot. Our experienced engineers help you do that by installing your equipment and preparing it for commissioning. Not only do they specialize in the equipment itself, they can also provide insights into how small adjustments will play out over years of operation.

Our locally based engineers make no assumptions about your operations, but take the time to get to know your unique circumstances. Putting installation in their hands means you can rest easy, as unwanted surprises are avoided. You can count on:

- Quick completion
- Ideal placement and setup
- Optimal performance from day one
- Recommendations for ideal operation and maintenance

Commissioning

Securing ideal operation is more than getting equipment into place. After verifying your equipment's installation, our experts can take charge of starting it up on board, making sure that this critical phase goes smoothly.

When we handle commissioning, you know your equipment and the processes it affects are fully optimized for safety and performance. Our specialists do test runs and performance checks, and even train your operators if needed. When they hand the operation over to you, they document it with an acceptance certificate and follow up some months later if needed.

Our commissioning process ensures:

- Resolution of all issues before handover
- Smooth integration with onboard control and alarm systems
- Equipment and process fine-tuning
- Advice for optimizing surrounding components and parameters

Maintenance services

Letting you count on performance

A well-crafted maintenance strategy keeps your total operating costs down by keeping your equipment's performance level up. It increases uptime, gives you transparent cost control and lengthens equipment lifespan. In fact, expert maintenance both improves the performance of your Alfa Laval equipment and helps you get more out of surrounding equipment.

Thanks to tireless R&D, we can offer unique solutions for Cleaning-in-Place (CIP) that cut man-hours, reconditioning that leaves equipment good as new, and meticulously designed spare parts that improve performance while extending service intervals. For the ultimate in spare parts efficiency, you can even set up an exclusive stock of parts – fabricated to your exact specifications and ready to ship the same day you ask for them.



Preventive maintenance

Preventive maintenance is the key to securing uptime and keeping surprises at bay. It reduces unplanned stops, increases equipment lifetime and improves operational safety. Our experts can help you form the optimal maintenance plan for your equipment, based on its application, usage and condition.

We can either do the maintenance for you on board, or we can provide you with the training and tools to do it yourself. Using the right tools and methods when disassembling and assembling takes less time and eliminates costly errors, while regular Cleaning-in-Place (CIP) and the use of quality spare parts keeps wear minimal and service intervals optimal.

Preventive maintenance gives you:

- Maximum operating reliability
- Minimized operating costs
- Longer equipment lifetime
- Opportunities to reduce spare parts stock

PHE and FWG reconditioning

Years of use can be wiped away with our advanced reconditioning of plate heat exchangers (PHEs) and freshwater generators (FWGs). At our workshops, we use specially developed tools to inspect and restore your plates and gaskets – no matter what equipment brand you use.

Gaskets are removed using liquid nitrogen for a gentle but clean separation. Following chemical cleaning, dye penetrants and UV illumination are used to detect cracks and micro-holes. Finally, gaskets of the right design and compound are bonded to the plates with the correct type and amount of glue. All this restores performance and lowers maintenance costs. We can supply you with freshly reconditioned plates in the meantime, so that you can continue operating while we work.

Our PHE and FWG reconditioning ensures:

- Removal of even small imperfections
- A tight, energy-efficient seal that lasts for years
- Guaranteed performance with a new warranty
- Extended PHE and FWG lifespan

Boiler repairs

To provide the most flexible possible solution, our engineers can carry out boiler repairs during your vessel's normal operation. With our presence around the world, we can quickly adjust start dates and team size to fit your schedule. If the schedule between ports gives you little time for repairs, we can compensate by bringing in additional factory-trained specialists to get the job done more quickly.

When we have specifications on hand, we can prepare modules on shore to shorten the repair process. While we work on your boiler, we can set up a portable boiler to ensure you maintain your steam supply and remain on schedule. If the repairs cannot be carried out during operation, our repair team can travel with your vessel to complete the job quickly when it reaches port.

Boiler repairs let you:

- Avoid boiler downtime that forces you to use diesel fuel
- Carry out repairs when it suits you best
- Maintain your schedule
- Avoid possible off-hire of vessel

Service kits

Alfa Laval service kits give you all you need to perform a specific service, whether an urgent repair or a scheduled overhaul. They contain all the up-to-date genuine spare parts required, as well as retrofit parts when applicable for older equipment.

Developed based on years of practical experience, the kits save time and money in key situations. Having an emergency kit for Aalborg burners on board allows quick repairs that can prevent serious consequences, such as loss of HFO and cargo heating. Dry dock kits take a proactive approach instead, preventing rush orders and added freight charges by ensuring that everything is on hand before your vessel arrives.

Alfa Laval service kits provide:

- All the right parts in one place
- Ensured compatibility with your equipment
- Convenience that reduces maintenance time and downtime
- Economy and peace of mind

Support services

Expert assistance anytime, anywhere

Every minute is costly when a problem slows you down. But with Alfa Laval, you're never alone. In person, by phone and even online, we can help you quickly troubleshoot and solve any issue.

We also partner with you to prevent issues from the start, through strategies like regular inspections, trainings and service follow-ups. Our Graduated Service Engineers, stationed in every part of the world, have in-depth knowledge that can both protect your equipment and improve the way you use it.

All of our support services have the same goal of maximizing your equipment's availability and uptime.



Troubleshooting

When equipment issues arise, Alfa Laval troubleshooters are always available to help. Whether you have an immediate disturbance or a long-term energy loss, our specialists have the in-depth knowledge – both theoretical and practical – to put it to rights.

Assisting you remotely or working on board, our troubleshooters find answers that minimize downtime and prevent losses or a potentially hazardous situation. They advise you of the root cause of the problem, providing detailed analysis, remedies and recommendations to keep it from arising again. If needed, they connect you with application experts, material experts and Alfa Laval product centres in order to find a permanent solution.

Our troubleshooting services help you:

- Restore and safeguard uptime
- Identify and remove the problem causes
- Improve and optimize operating conditions
- Reduce costs due to loss and excessive maintenance

Fuel Management Course

As new regulations and other drivers affect your business, Alfa Laval trainings can help you adapt to the new conditions and optimize your onboard operations. A good example is the Fuel Management Course, jointly held by Alfa Laval and Veritas Petroleum Services (VPS) for the past 20 years.

Today's course focuses on the fuel complexities since the introduction of Emission Control Areas (ECAs). It explores the operational risks in switching between residual fuels and low-sulphur distillates or new ECA fuels (NEFs), as well as the strategies for avoiding them. Answers and recommendations are provided in areas such as bunkering, sampling, storing, handling and treatment of the fuel on board.

The Fuel Management Course aids you in:

- Understanding fuel qualities and related challenges
- Mitigating the risks associated with fuel changeover
- Developing effective multi-fuel management
- Adapting fuel treatment equipment for best performance

Alfa Laval Test & Training Centre programmes

Alfa Laval can provide training on board and at sites around the world. One of those sites is the Alfa Laval Test & Training Centre in Aalborg, Denmark (see page 96), which is a full-size machinery room on land. Here you can explore the interactions between different types of equipment and even entire process lines as you look to optimize your fleet.

Utilizing the centre's unique 250 m² testing space and accompanying training facilities, we can arrange custom trainings and other programmes to suit your particular needs. With the wide range of Alfa Laval equipment on site, we can provide hands-on opportunities to explore how improvements might be made on your own vessels.

The Alfa Laval Test & Training Centre offers:

- Customized trainings focused on your fleet's needs
- Up-close access to a wide range of Alfa Laval equipment
- Possibilities to explore equipment interactions
- Opportunities to interact with Alfa Laval experts

LNG lifetime extension programme

Economic realities have made it attractive to extend the service life of LNG vessels. Alfa Laval helps ensure the continued performance of your inert gas generator by inspecting critical components, e.g. the combustion chamber, valves and chiller unit. We then advise you as to what parts should be replaced and why. Together, we form a detailed plan to ensure long-term performance with no surprise costs.

Improvement services

Optimizing for an even stronger future

The better your equipment performs, the more you benefit from it. Our improvement services help you optimize performance, or even take it to the next level. As business drivers and regulations change, we can help you reconfigure your equipment to match, or provide upgrades and retrofits to let you take advantage of the latest technical developments.

Best of all, optimization can be done without a large investment. There are many smart, cost-effective ways to improve operations and your bottom line. Our Alfa Laval Automated Fuel Changeover System (ACS), for example, gives you cutting-edge control of fuel viscosity to safeguard the changeover between residual fuels and distillates. And Alfa Laval PureBilge lets you treat bilge water continuously in any conditions – doing away with the hassle and cost of messy, oily filters.

With expert guidance, the right upgrades and smart retrofits, we help you achieve success and meet the future.



PureDry retrofit

Retrofitting with Alfa Laval PureDry lets you take full control over your waste oil – reducing its volume by 99%. By installing this innovative high-speed separator, you can remove every drop of water the waste oil contains, sending it on to the bilge water treatment system for discharge overboard. The suspended particles are concentrated into a tiny amount of super-dry solids, leaving only purified oil.

If fuel waste and lube waste are directed into separate tanks, the benefits are even greater. When waste fuel oil is separated with PureDry, as much as 1-2% of the consumed fuel volume can be returned to your bunker tank and reused as ISO-quality fuel. That means considerable fuel savings and an even faster payback on your investment.

No barges, no incineration

PureDry eliminates the liquid component of waste oil, along with its question marks and the messy practice of pumping it onto barges. Also gone is the need for sludge incineration, which can consume a tonne of diesel for every three tonnes of sludge. The super-dry solids that remain are easily disposed of just like any other landed waste.

Benefits of the PureDry retrofit include:

- Minimized sludge volumes
- Simplified waste disposal
- No waste pumping or incineration
- Opportunities for substantial fuel savings



Alfa Laval PureDry

WHR retrofit for auxiliary engines

Your fuel costs and emissions can be reduced with a waste heat recovery (WHR) retrofit for your auxiliary engines. The Alfa Laval Aalborg XS-TC7A is a compact and lightweight economizer that we tailor to your ship and its engine design. Though it has a minimal footprint, it lets you effectively produce steam using heat energy from the auxiliary engine exhaust gas, both in port and en route.

The retrofit offers significant reductions in fuel consumption and can provide an important steam boost. This is especially true during slow steaming, when the reduced gas flow and temperature from some engines may be insufficient to meet operating steam requirements. By augmenting steam production, the retrofit can reduce the need to use your oil-fired boiler.

Benefits of the WHR retrofit include:

- Quick return on investment
- Sufficient steam production while slow steaming
- Reduced fuel consumption by the oil-fired boiler
- Reduced emissions from the oil-fired boiler



Alfa Laval Aalborg
XS-TC7A

Automated Fuel Changeover System (ACS) retrofit

If your vessel has no scrubber, travelling in and out of Emission Control Areas (ECAs) means switching between fuels. Changeover between residual fuels and low-sulphur distillates means potentially engine-stopping risks, which can be removed by retrofitting with the Alfa Laval Automated Fuel Changeover System (ACS).

The ACS is a complete changeover solution, supplying not only vital cooling, but also advanced automation for perfect control over fuel viscosity and lubricity. Safe, simple and fully automatic, it installs as a skid-mounted module and integrates with any fuel booster system from any supplier.

Alfa Laval Touch Control for existing boilers

Alfa Laval Touch Control is a reliable, easy-to-use control system based on a programmable logic controller (PLC). Already the standard control system for new Alfa Laval Aalborg boiler plants, it can also be installed as a control system replacement on existing plants.

Replacing a boiler's original control system with Alfa Laval Touch Control has a wide range of benefits. Above all, it provides intuitive control that enables faster, smarter decisions – which helps to optimize boiler use. The graphical interface gives a full overview of the plant, with access to any plant control function in two touches of the screen. Plus there are user defined trend pages to make sense of data, and user limits that can be set to protect key functions.

Benefits of switching to Alfa Laval Touch Control include:

- Simpler operation through an intuitive graphical interface
- Easier optimization due to full plant overview
- Upgradable firmware for easy integration of new features
- Future-proof expansion due to modular construction



Alfa Laval Touch Control

Benefits of the ACS retrofit include:

- Cutting-edge control of fuel viscosity and lubricity
- Eliminated risk in changing between fuels
- Fully automatic changeover procedures
- Easy integration with any booster system



Alfa Laval Automated Fuel
Changeover System (ACS)

Monitoring services

Solving problems before they start

Avoiding the unexpected is among the best ways to save time and money. Our monitoring solutions let you achieve lower cost of ownership while experiencing even greater peace of mind.

Monitoring is a means of identifying opportunities and stopping problems before they start. Inspections or audits of your equipment are one approach. Another is continuous monitoring, for example of your spare parts consumption, which keeps you informed of any change that might affect performance. The earlier you identify an issue, the smaller and more cost-effective the solution to correct it.



Condition monitoring spare parts

Your consumption of spare parts can speak volumes about the condition of your equipment and the way you use it. By keeping track of the type and number of parts consumed by a given piece of equipment, we can use the numbers to identify potential issues in maintenance and operating practices.

Catching issues early on means we can find solutions before they become a real problem. That way you only need simple fixes, such as equipment optimization or a specific training course. You save not only by reducing your spare parts consumption, but also by improving the performance of your equipment.

Condition monitoring spare parts allows:

- Identification of problems while still small
- Reduction of excessive parts consumption
- Improvements in operating procedure
- Pro-active solutions to improve performance

Performance Audit

Knowing in advance whether something will break, or if procedures could be handled faster, cheaper and better, is a key to improving safety, performance and economy. This sort of foresight and insight is exactly what an Alfa Laval Performance Audit provides.

During a Performance Audit, our specialists investigate the actual operating performance of your Alfa Laval equipment with the goal of optimizing it and reducing costs wherever possible. Engaging continuously with your engineers to understand the conditions and priorities on board your ship, they look at your equipment, as well as its settings and its usage. With their findings, they help you to optimize maintenance schedules, identify ideal throughput and load, and secure the highest possible equipment uptime.

Alfa Laval Performance Audits can:

- Maximize equipment efficiency and reliability
- Minimize spare parts and energy consumption
- Upgrade crew knowledge and improve equipment handling
- Identify potential process and installation improvements

Tomorrow's solutions

At the Alfa Laval Test & Training Centre in Aalborg, Denmark, new developments are taking shape. With its 250 m² testing space, the centre is the closest thing on land to the machinery room of a full-sized commercial vessel. Here we test equipment, applications and even multiple process lines in full scale, pursuing the innovations that will serve you tomorrow.

Alfa Laval AQUA Blue

p. 32

Freshwater generation

Alfa Laval PureVent

p. 39

Crankcase gas cleaning

Alfa Laval FCM One

p. 49

Fuel conditioning system for diesel engines

Air outlet

Alfa Laval Heat exchangers

p. 24-29

General heating
Scrubber cooling
Water cooling
Steam dump condensing
Oil preheating

MAN engine
(L28/32, 9 cylinders)

Alfa Laval Filters

p. 52

Fuel oil filtration
Lube oil filtration

Engine air inlet

Day tank

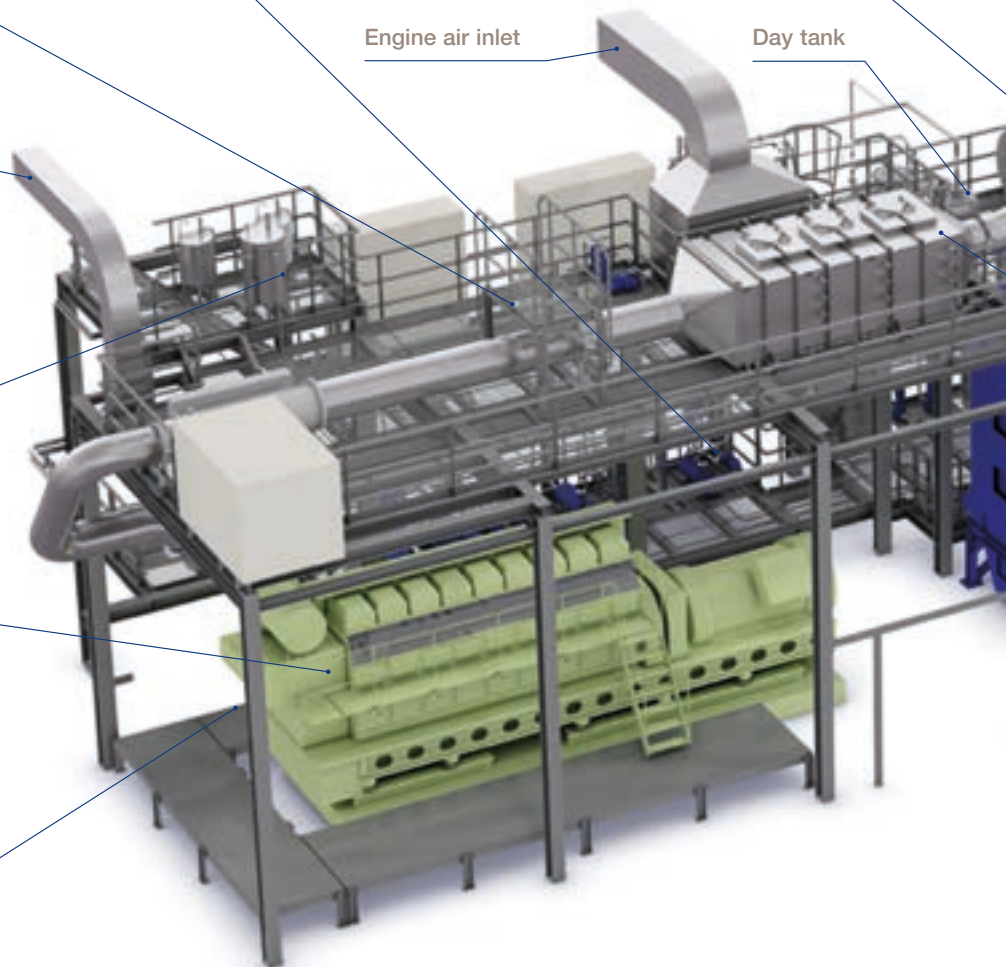

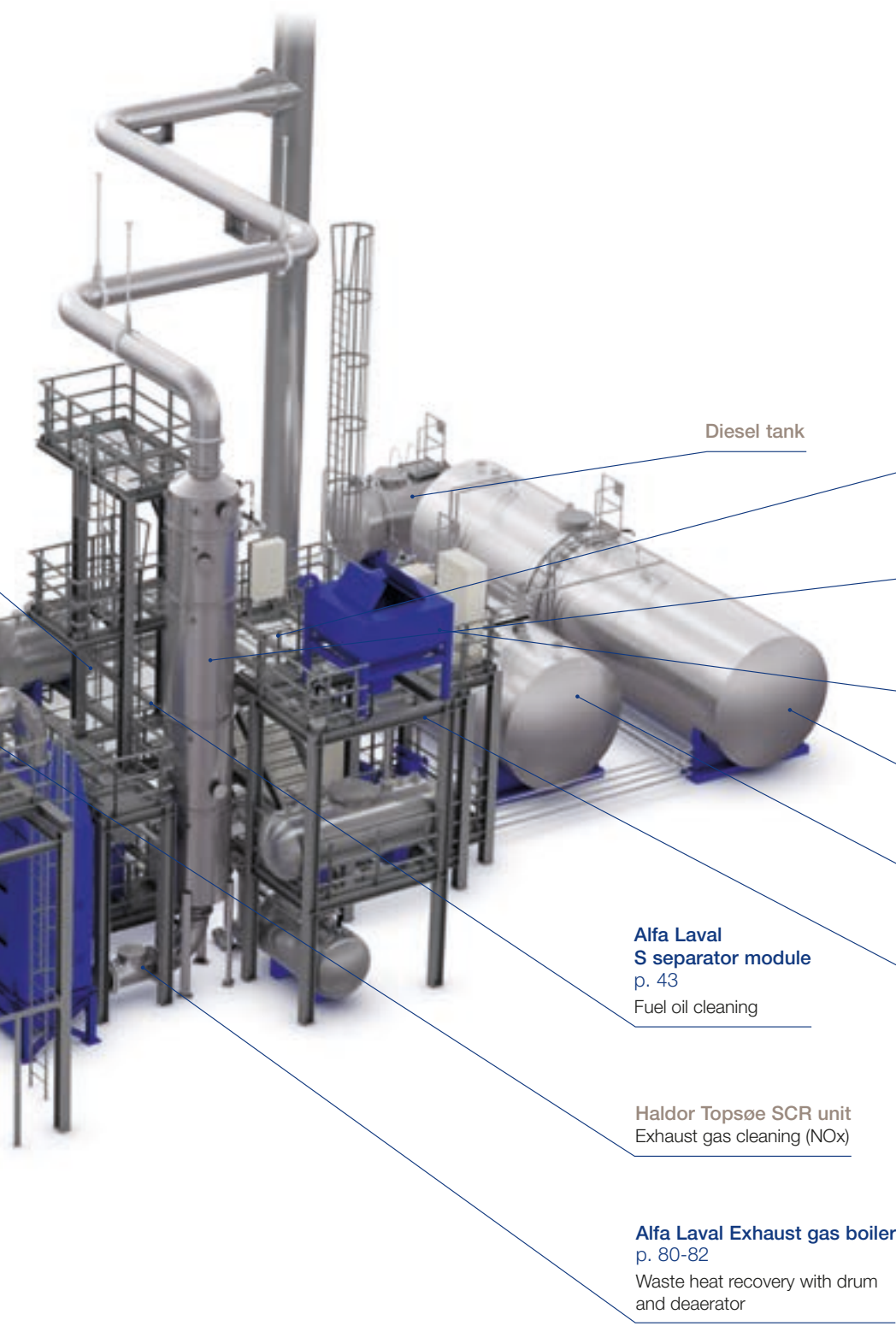

Diesel tank

**Alfa Laval Gunclean
Toftejorg i40 S/D**
p. 71
Cargo tank cleaning

Alfa Laval PureSOx
p. 36
Exhaust gas cleaning (SOx)

Scrubber dosing tank
Exhaust gas cleaning (SOx)

HFO tank

Wastewater tank

**Alfa Laval
S separator module**
p. 43
Fuel oil cleaning

Alfa Laval PureBallast 3.1
p. 14
Ballast water treatment

Haldor Topsøe SCR unit
Exhaust gas cleaning (NOx)

Alfa Laval Exhaust gas boiler
p. 80-82
Waste heat recovery with drum
and deaerator

Welcome aboard

You can also explore our products
online at www.alfalaval.com/marine



Alfa Laval in brief

Alfa Laval is a leading global provider of specialized products and engineering solutions.

Our equipment, systems and services are dedicated to helping customers to optimize the performance of their processes. Time and time again. We help our customers to heat, cool, separate and transport products such as oil, water, chemicals, beverages, foodstuffs, starch and pharmaceuticals.

Our worldwide organization works closely with customers in almost 100 countries to help them stay ahead.

How to contact Alfa Laval

Contact details for all countries are continually updated on our web site. Please visit www.alfalaval.com to access the information.

Pure Thinking, PureBallast, PureBlige, PureDry, PureNOx, PureSOx, PureSOX H2O, PureVent, Aalborg, AlfaCond, AlfaNova M, AlfaRex, Alpacon, AQUA Blue, CentriLock, CentriShoot, emmie, FCM One, Framo, G-pass, Gunclean Toffejorg, PreBlige, Smit Gas and XLrator are trademarks owned by Alfa Laval Corporate AB. Alfa Laval is a trademark registered and owned by Alfa Laval Corporate AB.

